

TPTZ Method¹

Method 8112

0.01 to 1.70 mg/L Fe

Powder Pillows or AccuVac[®] Ampuls

Scope and application: For water, wastewater and seawater.

¹ Adapted from G. Frederic Smith Chemical Co., *The Iron Reagents*, 3rd ed. (1980).



Test preparation

Before starting

To make sure that all forms of the metal are measured, digest the sample with heat and acid. Use the mild or vigorous digestion. Refer to the *Water Analysis Guide* for more information.

Wash all glassware with detergent. Rinse with tap water. Rinse again with 1:1 Hydrochloric Acid Solution. Rinse a third time with high-quality deionized water. These steps will remove deposits that can cause slightly high results.

Always do tests in sample cells or AccuVac[®] Ampuls. Do not put the instrument in the sample or pour the sample into the cell holder.

Make sure that the sample cells are clean and there are no scratches where the light passes through them.

Rinse the sample cell and cap with the sample three times before the sample cell is filled.

Make sure that there are no fingerprints or liquid on the external surface of the sample cells or AccuVac[®] Ampuls. Wipe with a lint-free cloth before measurement.

Cold waters can cause condensation on the sample cell or bubbles in the sample cell during color development. Examine the sample cell for condensation or bubbles. Remove condensation with a lint-free cloth. Invert the sample cell to remove bubbles.

Install the instrument cap over the cell holder before ZERO or READ is pushed.

After the test, immediately empty and rinse the sample cell. Rinse the sample cell and cap three times with deionized water.

For the best results, measure the reagent blank value for each new lot of reagent. Replace the sample with deionized water in the test procedure to determine the reagent blank value. Subtract the reagent blank value from the sample results.

Review the Safety Data Sheets (MSDS/SDS) for the chemicals that are used. Use the recommended personal protective equipment.

Dispose of reacted solutions according to local, state and federal regulations. Refer to the Safety Data Sheets for disposal information for unused reagents. Refer to the environmental, health and safety staff for your facility and/or local regulatory agencies for further disposal information.

Items to collect

Powder pillows

Description	Quantity
TPTZ Iron Reagent Powder Pillows, 10-mL	1
Sample cells, 25-mm (10 mL)	2

Refer to [Consumables and replacement items](#) on page 6 for order information.

AccuVac Ampuls

Description	Quantity
TPTZ Low Range Iron Reagent AccuVac Ampul	1
Beaker, 50-mL	1

AccuVac Ampuls (continued)

Description	Quantity
Stopper for 18-mm tubes and AccuVac Ampuls	1
Sample cell, 25-mm (10 mL)	1

Refer to [Consumables and replacement items](#) on page 6 for order information.

Sample collection and storage

- Collect samples in clean glass or plastic bottles that have been cleaned with 6 N (1:1) hydrochloric acid and rinsed with deionized water.
- To preserve samples for later analysis, adjust the sample pH to less than 2 with concentrated nitric acid (about 2 mL per liter). No acid addition is necessary if the sample is tested immediately.
- To measure only dissolved iron, filter the sample immediately after collection and before acidification.
- Keep the preserved samples at room temperature for a maximum of 6 months.
- Before analysis, adjust the pH to 3–4 with 5.0 N sodium hydroxide standard solution. Do not exceed pH 5 or iron may precipitate.
- Correct the test result for the dilution caused by the volume additions.

Powder pillow procedure

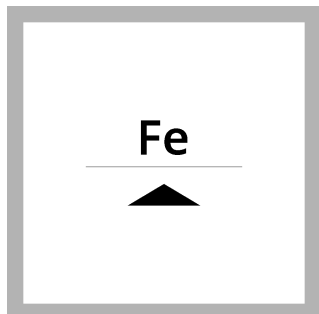

1. Set the instrument to iron (Fe).

For DR300, push the up arrow button. For PCII, push the menu button, checkmark button, then the menu button again.

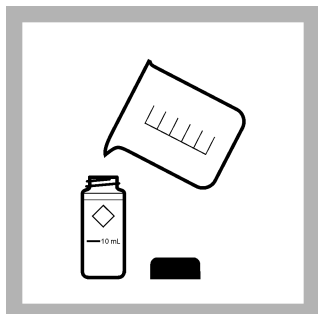

2. Prepare the sample:

Rinse a sample cell and cap three times with sample. Fill the sample cell to the 10-mL mark with sample.

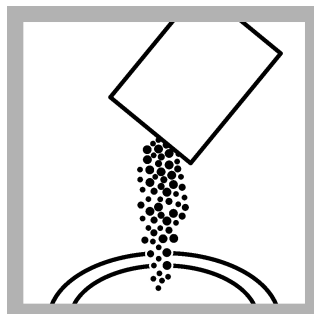

3. Add the contents of one TPTZ Iron Reagent Powder Pillow to the sample cell.

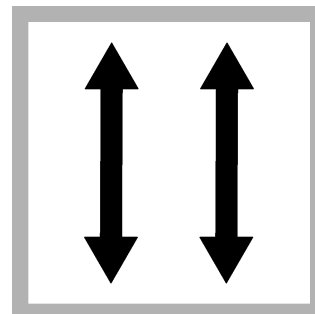

4. Put the stopper on the sample cell. Shake the sample cell for about **30 seconds** to dissolve the reagent..

A blue color will show if iron is in the sample.



5. Set and start a timer for 3 minutes. A 3-minute reaction time starts.

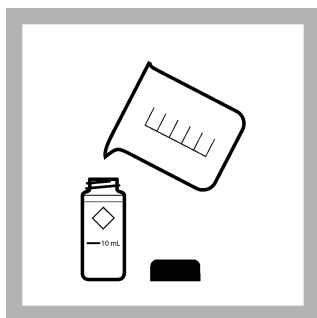

6. **Prepare the blank:** Rinse a sample cell and cap three times with sample. Fill the sample cell to the 10-mL mark with sample. Close the sample cell.

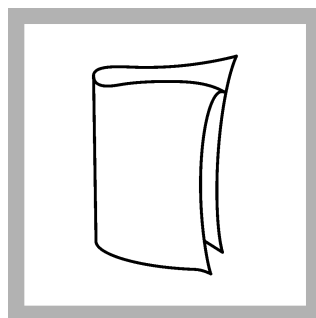

7. When the timer expires, clean the blank sample cell.

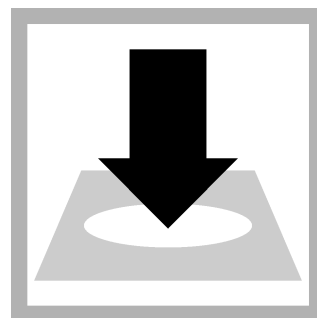

8. Insert the blank into the cell holder. Point the diamond mark on the sample cell toward the keypad.

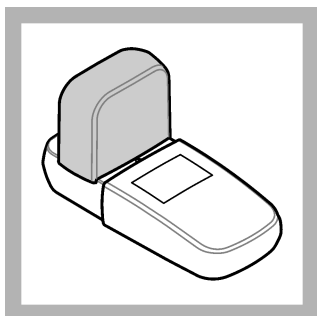

9. Install the instrument cap over the cell holder.

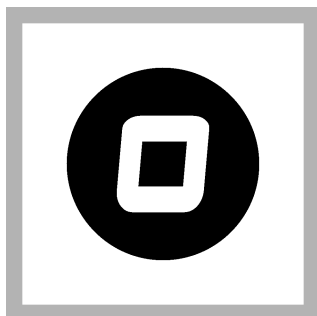

10. Push **ZERO**. The display shows "0.00".

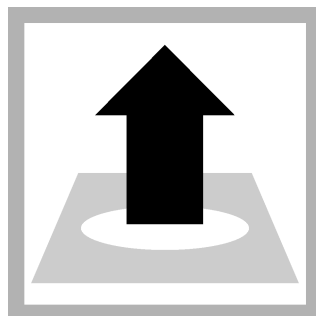

11. Remove the sample cell from the cell holder.

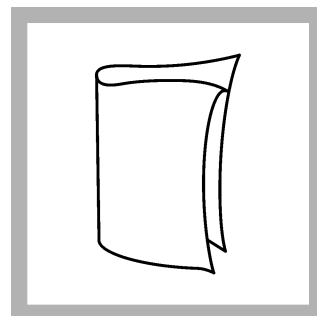

12. Clean the prepared sample cell.

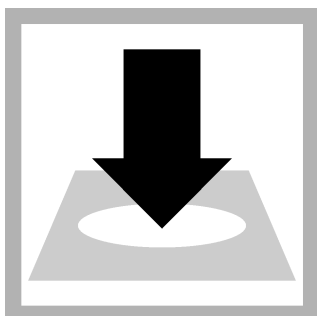

13. Insert the prepared sample into the cell holder. Point the diamond mark on the sample cell toward the keypad.

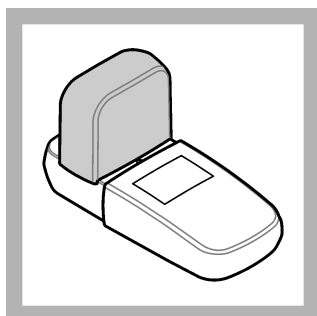

14. Install the instrument cap over the cell holder.

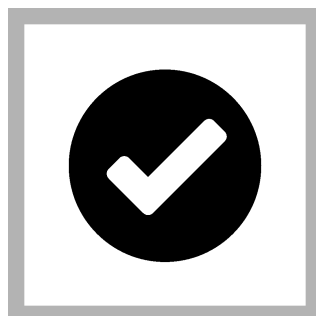

15. Push **READ**. Results show in mg/L iron (Fe).

AccuVac[®] Ampul procedure

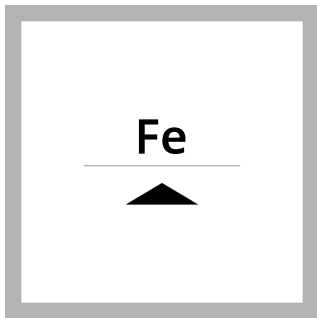

1. Set the instrument to iron (Fe).

For DR300, push the up arrow button. For PCII, push the menu button, checkmark button, then the menu button again.

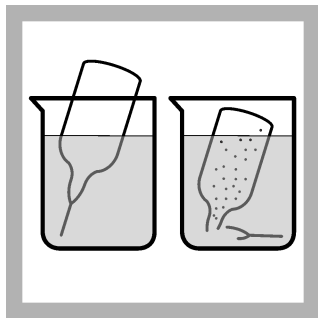

2. Prepare the sample:

Collect at least 40 mL of sample in a 50-mL beaker. Fill the AccuVac Ampul with sample. Keep the tip immersed while the AccuVac Ampul fills completely.

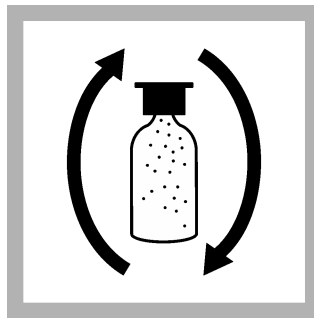

3. Quickly invert the AccuVac Ampul several times to mix. A blue color will show if iron is in the sample.

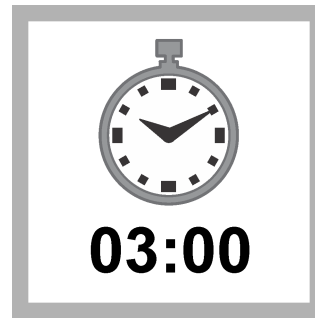

4. Set and start a timer for 3 minutes. A 3-minute reaction time starts.

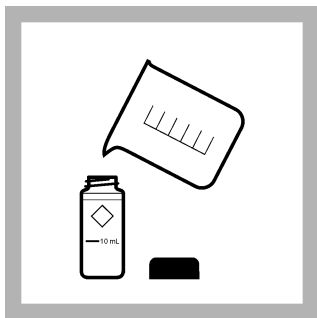

5. Prepare the blank:

Rinse a sample cell and cap three times with sample. Fill the sample cell to the 10-mL mark with sample. Close the sample cell.

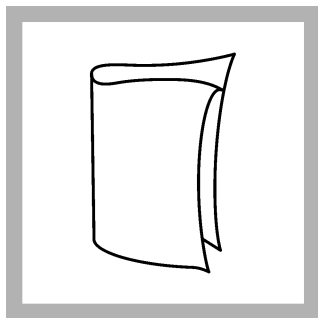

6. When the timer expires, clean the blank sample cell.

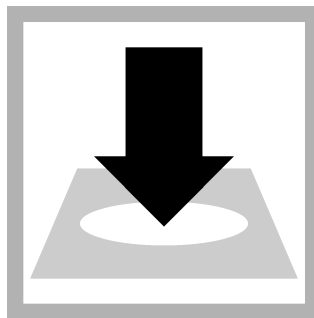

7. Insert the blank into the cell holder. Point the diamond mark on the sample cell toward the keypad.

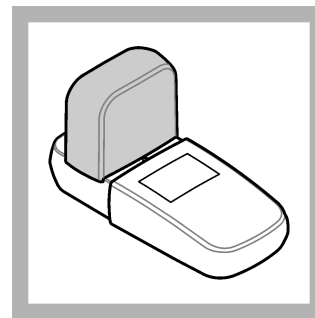

8. Install the instrument cap over the cell holder.

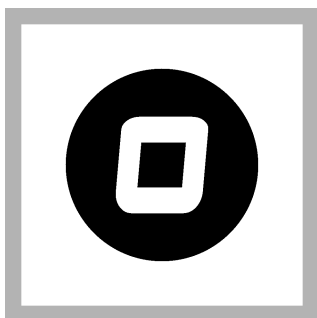

9. Push ZERO. The display shows "0.00".

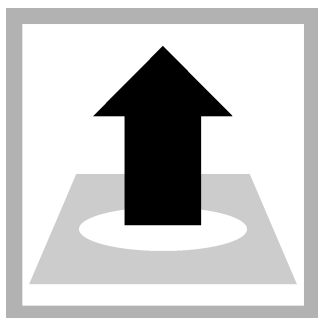

10. Remove the sample cell from the cell holder.

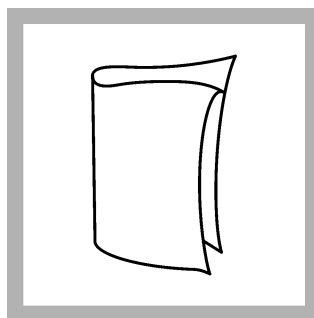

11. Clean the AccuVac Ampul.

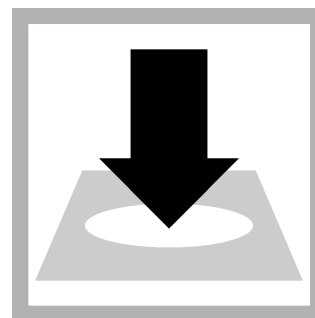

12. Insert the prepared sample AccuVac Ampul into the cell holder.

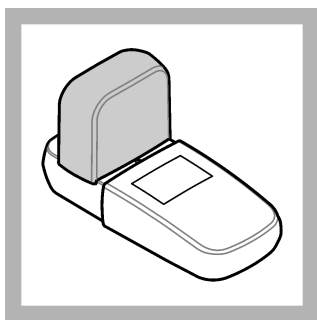

13. Install the instrument cap over the cell holder.

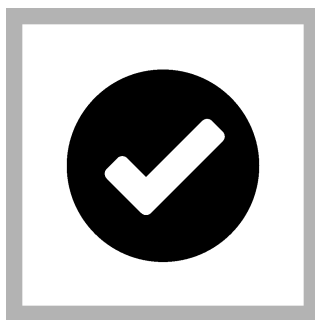

14. Push **READ**. Results show in mg/L iron (Fe).

Interferences

Interferences were tested with an iron concentration of 0.5 mg/L Fe. The following do not interfere with this method when present up to the levels shown.

Interfering substance	Interference level
Cadmium	4.0 mg/L
Chromium ³⁺	0.25 mg/L
Chromium ⁶⁺	1.2 mg/L
Cobalt	0.05 mg/L
Copper	0.6 mg/L
Cyanide	2.8 mg/L
Manganese	50.0 mg/L
Mercury	0.4 mg/L
Molybdenum	4.0 mg/L
Nickel	1.0 mg/L
Nitrite Ion	0.8 mg/L
Color or turbidity	If the sample, without a TPTZ Iron Reagent Powder Pillow, has a color or turbidity more than the blank (deionized water plus TPTZ Iron Reagent), then use the sample as the blank. Refer to the powder pillow procedure.
pH	<p>After the addition of reagent, a sample pH of less than 3 or more than 4 may inhibit color formation. The developed color fades quickly or causes turbidity. Adjust the sample pH in the sample cell before the addition of reagent:</p> <ol style="list-style-type: none"> 1. Use a pH meter or pH paper to measure the current pH. 2. Add an applicable amount of iron-free acid or base such as 1.0 N Sulfuric Acid Standard Solution or 1.0 N Sodium Hydroxide Standard Solution to adjust the sample pH to between 3 and 4.¹ 3. Make a volume correction if significant volumes of acid or base are used.

Accuracy check

Standard additions method

Use the standard additions method to validate the test procedure, reagents and instrument and to find if there is an interference in the sample.

Items to collect:

- Iron Standard Solution Voluette Ampule, 25 mg/L Fe
- Pipet, TenSette®, 0.1–1.0 mL and pipet tips

¹ Refer to [Consumables and replacement items](#) on page 6 for order information.

- Mixing cylinders, 50-mL (3)
1. Prepare three spiked samples: use the TenSette pipet to add 0.1 mL, 0.2 mL and 0.3 mL of the standard solution, respectively, to three 25-mL portions of fresh sample. Mix well.
 2. Use the test procedure to measure the concentration of each of the spiked samples. Start with the smallest sample spike. Measure each of the spiked samples in the instrument.
 3. Compare the expected result to the actual result. The expected iron concentration increase is 0.1 mg/L for each 0.1 mL of standard that is added.

Method performance

The method performance data that follows was derived from laboratory tests that were measured on a DR300 and a Pocket Colorimeter II during ideal test conditions. Users can get different results under different test conditions.

Precision (95% confidence interval)
1.00 ± 0.02 mg/L Fe

Summary of method

The TPTZ Iron Reagent forms a deep blue-purple color with ferrous iron (Fe²⁺). The indicator is combined with a reducing agent that converts precipitated or suspended iron, such as rust, to the ferrous state. The amount of ferric iron (Fe³⁺) can be determined as the difference between the results of a ferrous iron test and the concentration of total iron.

Consumables and replacement items

Required reagents

Description	Quantity/test	Unit	Item no.
TPTZ Iron Reagent Powder Pillow, 10-mL	1	100/pkg	2608799
OR			
TPTZ Low Range Iron Reagent AccuVac [®] Ampul	1	25/pkg	2510025

Required apparatus (powder pillows)

Description	Quantity/test	Unit	Item no.
Sample cells, 10-mL round, 25 mm x 60 mm	2	6/pkg	2427606

Required apparatus (AccuVac Ampul)

Description	Quantity/Test	Unit	Item no.
Sample cell, 10-mL round, 25 mm x 60 mm	1	6/pkg	2427606
Beaker, 50 mL	1	each	50041H
Stoppers for 18-mm tubes and AccuVac Ampuls	2	6/pkg	173106

Recommended standards and apparatus

Description	Unit	Item no.
Iron Standard Solution, 10-mL Voluette [®] Ampule, 25-mg/L Fe	16/pkg	1425310
Ampule Breaker, 10-mL Voluette [®] Ampules	each	2196800
Metals Drinking Water Standard, LR for Cu, Fe, Mn	500 mL	2833749

Recommended standards and apparatus (continued)

Description	Unit	Item no.
Metals Drinking Water Standard, HR for Cu, Fe, Mn	500 mL	2833649
Water, deionized	4 L	27256

Optional reagents and apparatus

Description	Unit	Item no.
AccuVac [®] Ampul Snapper	each	2405200
AccuVac [®] Ampul vials for sample blanks	25/pkg	2677925
Iron Standard Solution, 100-mg/L Fe	100 mL	1417542
Iron Standard Solution, 10-mg/L Fe	500 mL	14049
Iron Standard Solution, 1-mg/L Fe	500 mL	13949
Mixing cylinder, graduated, 50 mL	each	189641
Nitric Acid, concentrated	500 mL	15249
Sulfuric Acid Standard Solution, 1 N	100 mL MDB	127032
Sodium Hydroxide Standard Solution, 1.0 N	100 mL MDB	104532
Stoppers for 18-mm tubes and AccuVac Ampuls	6/pkg	173106
Pipet, TenSette [®] , 0.1–1.0 mL	each	1970001
Pipet tips for TenSette [®] Pipet, 0.1–1.0 mL	50/pkg	2185696
Pipet tips for TenSette [®] Pipet, 0.1–1.0 mL	1000/pkg	2185628
Flask, volumetric, Class A, 500 mL, glass	each	1457449
Pipet, volumetric 5.00-mL	each	1451537
Pipet filler, safety bulb	each	1465100
Paper, pH, 0–14 pH range	100/pkg	2601300



FOR TECHNICAL ASSISTANCE, PRICE INFORMATION AND ORDERING:

In the U.S.A. – Call toll-free 800-227-4224

Outside the U.S.A. – Contact the HACH office or distributor serving you.

On the Worldwide Web – www.hach.com; E-mail – techhelp@hach.com

HACH COMPANY
WORLD HEADQUARTERS
Telephone: (970) 669-3050
FAX: (970) 669-2932