



POCKET COLORIMETER™ II
ANALYSIS SYSTEMS
INSTRUCTION MANUAL

Reactive Phosphorous
Phosphonates

Table of Contents

Safety Precautions	1-7
Laboratory Safety	1-7
Use of Hazard Information.....	1-7
Precautionary Labels.....	1-8
Specifications.....	1-9
Instrument Keys and Display.....	1-11
Instrument Cap Cord.....	1-12
Phosphorus, Reactive	1-15
Using Powder Pillows (USEPA accepted for reporting).....	1-16
Using AccuVac® Ampuls (USEPA accepted for reporting)	1-20
Sampling and Storage.....	1-24
Accuracy Check	1-24
Interferences.....	1-25
Method Performance.....	1-27
Summary of Method	1-28
Reagents and Apparatus.....	1-28
Digestion for Total Phosphorus.....	1-31
Measuring Hints	1-31

Table of Contents, continued

Sampling and Storage	1-35
Interferences	1-35
Summary of Method.....	1-36
Reagents and Apparatus	1-37
Phosphonates	1-39
Sampling and Storage	1-47
Accuracy Check.....	1-47
Standard Calibration Adjust Method.....	1-49
Interferences	1-49
Summary of Method.....	1-51
Reagents and Apparatus	1-52
Instrument Operation	2-3
Key Functions.....	2-3
Menu Selections	2-4
Switching Ranges.....	2-4
Setting the Time	2-4
Recalling Stored Measurements	2-5
Battery Installation	2-6

Table of Contents, continued

Error Codes.....	2-9
Error Messages.....	2-9
Standard Calibration Adjust	2-13
User-Entered Calibration	2-15
Overview.....	2-15
Calibration Procedure Using Prepared Standards	2-17
Entering a Predetermined Calibration Curve	2-20
Editing a User-entered or Factory Calibration Curve	2-22
Exiting the Calibration Routine.....	2-24
Deleting Calibration Points	2-24
Retrieving the Factory Calibration.....	2-25
Maximum/Minimum Displayed Value.....	2-26
Certification.....	2-29
How to Order.....	2-35
Repair Service	2-37
Warranty	2-38

Safety Precautions

Please read this entire manual before unpacking, setting up, or operating this instrument. Pay particular attention to all danger and caution statements. Failure to do so could result in serious injury to the operator or damage to the equipment.

To ensure the protection provided by this equipment is not impaired, do not use or install this equipment in any manner other than that which is specified in this manual.

Laboratory Safety

As part of good laboratory practice, please familiarize yourself with the reagents used in these procedures. Read all product labels and the material safety data sheets (MSDS) before using them. It is always good practice to wear safety glasses when handling chemicals. Follow instructions carefully. Rinse thoroughly if contact occurs. If you have questions about reagents or procedures, please contact the manufacturer or distributor.

Use of Hazard Information

If multiple hazards exist, this manual will use the signal word (Danger, Caution, Note) corresponding to the greatest hazard.

Safety Precautions, continued

DANGER

Indicates a potentially or imminently hazardous situation which, if not avoided, could result in death or serious injury.

CAUTION

Indicates a potentially hazardous situation that may result in minor or moderate injury.

NOTE

Information that requires special emphasis.

Precautionary Labels

Please pay particular attention to labels and tags attached to the instrument. Personal injury or damage to the instrument could occur if not observed.



This symbol, if noted on the instrument, references the instruction manual for operational and/or safety information.

Specifications

Lamp: Light emitting diode (LED)

Detector: Silicon photodiode

Photometric precision: ± 0.015 Abs

Filter bandwidth: 15 nm

Wavelength: 600 nm

Absorbance range: 0–2.5 Abs

Dimensions: 3.2 x 6.1 x 15.2 cm (1.25 x 2.4 x 6 inches)

Weight: 0.2 kg (0.43 lbs)

Sample cells: 25 mm (10 mL mark), AccuVac[®] Ampuls

Operating conditions: 0 to 50 °C; 0 to 90% relative humidity (noncondensing)

Power supply: Four AAA alkaline batteries; approximate life is 2000 tests*

* Backlight usage will decrease battery life.

OPERATION

DANGER

Handling chemical samples, standards, and reagents can be dangerous. Review the necessary Material Safety Data Sheets and become familiar with all safety procedures before handling any chemicals.

DANGER

La manipulation des échantillons chimiques, étalons et réactifs peut être dangereuse. Lire les Fiches de Données de Sécurité des Produits (FDSP) et se familiariser avec toutes les procédures de sécurité avant de manipuler tous les produits chimiques.

PELIGRO

La manipulación de muestras químicas, estándares y reactivos puede ser peligrosa. Revise las fichas de seguridad de materiales y familiarícese con los procedimientos de seguridad antes de manipular productos químicos.

GEFAHR

Das Arbeiten mit chemischen Proben, Standards und Reagenzien ist mit Gefahren verbunden. Es wird dem Benutzer dieser Produkte empfohlen, sich vor der Arbeit mit sicheren Verfahrensweisen und dem richtigen Gebrauch der Chemikalien vertraut zu machen und alle entsprechenden Materialsicherheitsdatenblätter aufmerksam zu lesen.

PERIGO

A manipulação de amostras, padrões e reagentes químicos pode ser perigosa. Reveja a folha dos dados de segurança do material e familiarize-se com todos os procedimentos de segurança antes de manipular quaisquer produtos químicos.

PERICOLO

La manipolazione di campioni, standard e reattivi chimici può essere pericolosa. La preghiamo di prendere conoscenza delle Schede Tecniche necessarie legate alla Sicurezza dei Materiali e di abituarsi con tutte le procedure di sicurezza prima di manipolare ogni prodotto chimico.

Instrument Keys and Display

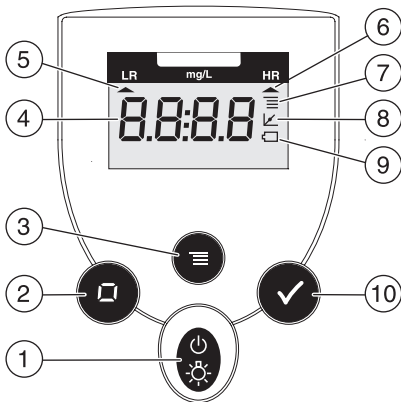

Item	Description
1	POWER/BACKLIGHT Key
2	ZERO/SCROLL Key
3	MENU Key
4	Numeric Display
5	Range Indicator
6	Range Indicator
7	Menu Indicator
8	Calibration Adjusted Indicator
9	Battery Low Indicator
10	READ/ENTER Key

Instrument Cap Cord

The instrument cap for the Pocket Colorimeter™ II doubles as a light shield. Accurate measurements cannot be obtained unless the sample or blank is covered with the cap. Use the instrument cap cord to secure the cap to the body of the colorimeter and prevent loss of the cap. See [Figure 1 on page 1–13](#).

1. Loop the instrument cap cord through the ring on the cap.
2. Remove the battery compartment cover. Press the knotted end of the cord into the hole indicated by the arrow.
3. Slide the cord into the slot on the battery compartment cover. Snap the cover into place.

Figure 1 Attaching the Instrument Cap Cord

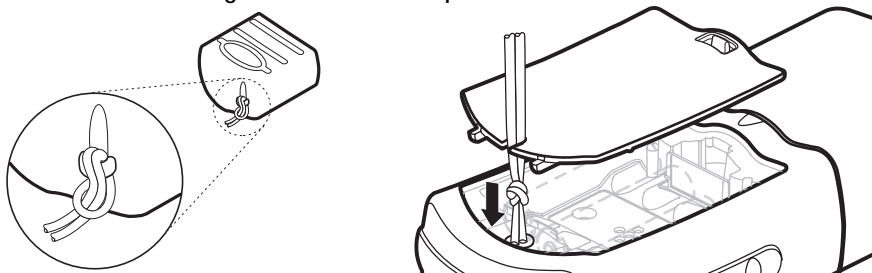

Phosphorus, Reactive (0.02 to 3.00 mg/L PO₄³⁻)

(Also called Orthophosphate)

Method 8048

For water, wastewater, and seawater.

PhosVer[®] 3 (Ascorbic Acid) Method*

USEPA accepted for reporting**

Measuring Hints

- For more accurate results, determine a reagent blank for each new lot of PhosVer 3 reagent. Perform [steps 1–10](#) using deionized water as the sample. Subtract this value from each result obtained with the same lot of PhosVer 3 reagent.
- The optional AccuVac[®] Snapper simplifies testing by retaining the broken tip, minimizing exposure to the sample, and providing controlled conditions for filling the ampule.

Note: *The Pocket Colorimeter II is designed to measure solutions contained in sample cells. **DO NOT** dip the meter in the sample or pour the sample directly into the cell holder.*

* Adapted from *Standard Methods for the Examination of Water and Wastewater*.

** Procedure is equivalent to Method 365.2 for wastewater and Standard Method 4500-P-E for drinking water.

Phosphorus, Reactive, continued

Using Powder Pillows (USEPA accepted for reporting)

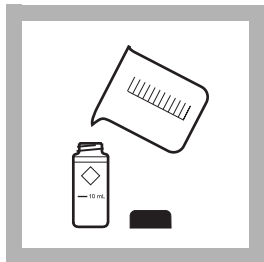

1. Fill a 10-mL cell to the 10-mL line with sample.

Note: *If samples cannot be analyzed immediately. See [Sampling and Storage](#) on page 24.*



2. Add the contents of one PhosVer 3 Powder Pillow to the cell (the prepared sample). Immediately cap and shake 10–15 seconds.

Note: *Wipe off any liquid or finger prints.*



3. Wait at least 2 min. (but less than 10 min.) for full color development before completing [steps 4–10](#).

Note: *If the sample was digested using the Digestion for Total Phosphorus (page 1–31), allow 10 min. for color development.*

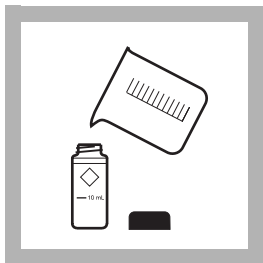

4. Fill a second sample cell with 10 mL of sample (the blank). Wipe off any liquid or fingerprints.

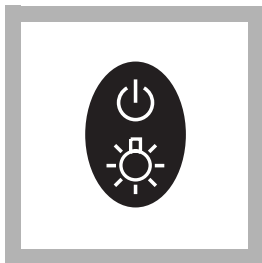

5. Press the **POWER** key to turn the meter on.
The arrow should indicate channel 1.

Note: See [page 2–4](#) for information on selecting the correct channel.

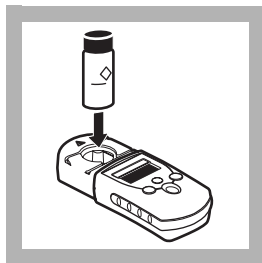

6. Place the blank into the cell holder.
Cover the sample cell with the instrument cap.

Phosphorus, Reactive, continued

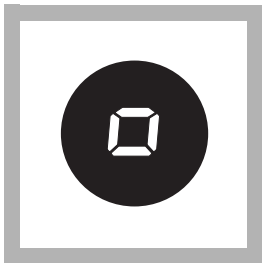

7. Press: **ZERO/SCROLL**

The meter will show “- - - -”, followed by “0.00”.

Remove the blank.

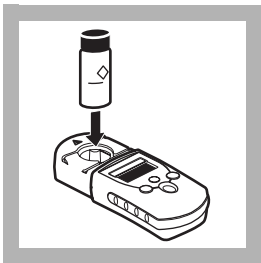

8. Place the prepared sample into the cell holder with the diamond mark facing the keypad.

Cover the sample cell with the instrument cap.



9. Press: **READ/ENTER**

The meter will show “- - - -”, followed by the results in mg/L phosphate (as PO_4^{3-}).

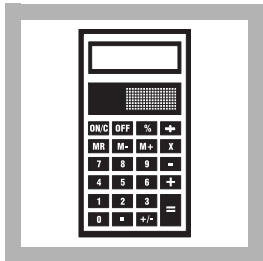

Table 1

To convert reading from	To	Multiply by
mg/L PO_4^{3-}	mg/L P_2O_5	0.747
mg/L PO_4^{3-}	mg/L P	0.326

10. Subtract the reagent blank from the reading for true concentration.

Note: *To convert results to other units, use the conversion table (Table 1).*

Phosphorus, Reactive, continued

Using AccuVac® Ampuls (USEPA accepted for reporting)



1. Fill a 10-mL sample cell to the 10-mL line with sample (the blank). Cap. Collect at least 40 mL of sample in a 50-mL beaker.

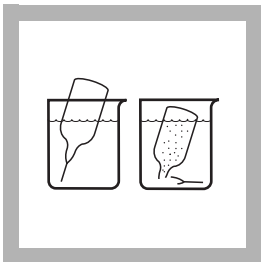

2. Fill a PhosVer® 3 Phosphate AccuVac® Ampul with sample.

Note: *Keep the tip of the ampule immersed until the ampule fills completely.*

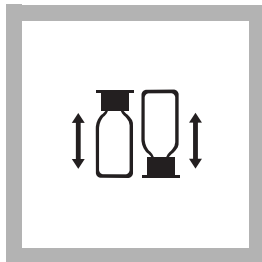

3. Place an ampule cap securely over the tip of the ampule. Invert the ampule 10–15 seconds to mix. Wipe off any liquid or fingerprints.



4. Wait at least 2 minutes (but no more than 10 minutes) for full color development before completing [steps 6–8](#).

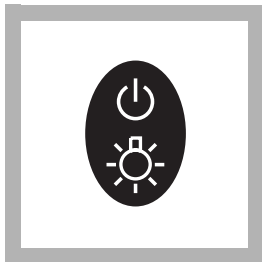

5. Press the **POWER** key to turn the meter on.

The arrow should indicate channel 1.

Note: See [page 2–4](#) for information on selecting the correct channel.

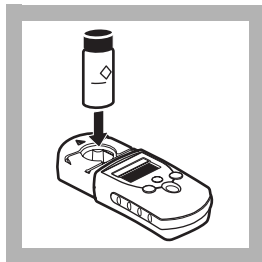

6. Place the blank into the cell holder.

Note: *Wipe off any liquid or finger prints.*

Cover the sample cell with the instrument cap.

Phosphorus, Reactive, continued

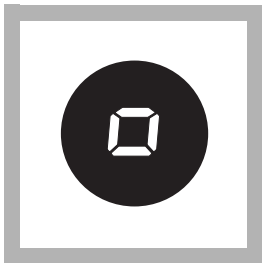

7. Press: ZERO/SCROLL

The instrument will turn on, and the display will show “- - - -”, followed by “0.00”.

Remove the blank.

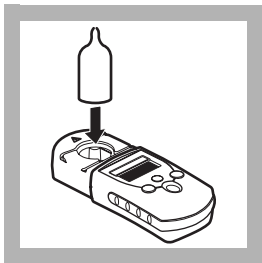

8. Place the ampule containing the prepared sample into the cell holder. Cover the ampule with the instrument cap.



9. Press: READ/ENTER

The meter will show “- - - -”, followed by the results in mg/L phosphate (as PO_4^{3-}).

Phosphorus, Reactive, continued

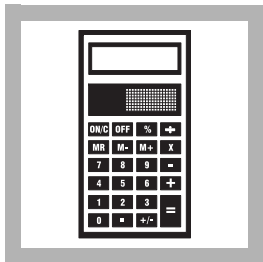

Table 2

To convert reading from	To	Multiply by
mg/L PO_4^{3-}	mg/L P_2O_5	0.747
mg/L PO_4^{3-}	mg/L P	0.326

10. Subtract the reagent blank from the reading for true concentration.

Note: To convert results to other units, use conversion [Table 2](#).

Sampling and Storage

Collect sample in plastic or glass bottles that have been cleaned with 1:1 Hydrochloric Acid Solution and rinsed with deionized water. Do not use commercial detergents containing phosphate for cleaning glassware used in phosphate analysis.

Best results are obtained when samples are analyzed as soon as possible after collection. If prompt analysis is impossible, preserve samples up to 48 hours by storing at or below 4 °C. Warm to room temperature before testing.

Accuracy Check

Standard Additions Method

1. Measure exactly 25.0 mL of sample into each of three 50-mL beakers.
2. Using the Ampule Breaker Kit, snap the neck off a Phosphate Voluette® Ampule Standard Solution, 50 mg/L PO_4^{3-} .
3. Use a TenSette® Pipet to add 0.1 mL, 0.2 mL, and 0.3 mL of standard, respectively, to the three 25-mL aliquots of sample. Mix each thoroughly.

- Analyze each standard addition sample as described in the procedure. The phosphate concentration should increase 0.2 mg/L for each 0.1 mL of standard added.

Standard Solution Method

Use a 3.00 mg/L phosphate standard solution in place of the sample. Perform the procedure as described above.

Multi-parameter standards that simulate typical wastewater and drinking water concentrations without dilution are available to confirm test results. See [Optional Reagents on page 29](#).

Standard Calibration Adjust Method

To perform a standard calibration adjustment using the 3.0 mg/L phosphate standard, or using an alternative concentration, see [Standard Calibration Adjust on page 2–13](#)

Interferences

Large amounts of turbidity may cause inconsistent results in the phosphate tests because the acid present in the powder pillow may dissolve some of the suspended particles and because of variable desorption of orthophosphate from the particles.

Phosphorus, Reactive, continued

For highly turbid or colored samples, add the contents of one Phosphate Pretreatment Powder Pillow to 25 mL of sample. Mix well. Use this solution (instead of the blank) to zero the instrument.

The following may interfere when present in concentrations exceeding those listed below:

Table 3

Aluminum	Greater than 200 mg/L
Arsenate	Interferes at any level.
Chromium	Greater than 100 mg/L
Copper	Greater than 10 mg/L
Hydrogen Sulfide	Interferes at any level
Iron	Greater than 100 mg/L
Nickel	Greater than 300 mg/L
pH, excess buffering	Highly buffered samples or extreme sample pH may exceed the buffering capacity of the reagents and require sample pretreatment. pH 2–10 is recommended.

Phosphorus, Reactive, continued

Table 3 (Continued)

Silica	Greater than 50 mg/L
Silicate	Greater than 10 mg/L
Turbidity (large amounts) or color	May cause inconsistent results because the acid in the powder pillow may dissolve some of the suspended particles and because of variable desorption of orthophosphate from the particles. For highly turbid or colored samples, add the contents of one Phosphate Pretreatment Powder Pillow (Cat. No. 14501-99) to 25 mL of sample. Mix well. Use this solution to zero the instrument.
Zinc	Greater than 80 mg/L

Method Performance

Typical Precision (95% Confidence Interval):

$$1.0 \pm 0.04 \text{ mg/L}$$

Estimated Detection Limit:

$$\text{EDL} = 0.02 \text{ mg/L}$$

Phosphorus, Reactive, continued

Summary of Method

Orthophosphate reacts with molybdate in an acid medium to produce a phosphomolybdate complex. Ascorbic acid then reduces the complex, giving an intense molybdenum blue color.

Reagents and Apparatus

Required Reagents

Description	Unit	Cat. No.
PhosVer [®] 3 Phosphate Reagent Powder Pillows.....	100/pkg 21060-69
OR		
PhosVer [®] 3 Phosphate Reagent AccuVac [®] Ampuls	25/pkg 25080-25

Required Apparatus

Description	Unit	Cat. No.
Beaker, 50-mL, low form	each 1080-41
Cap, ampule, blue	25/pkg 1731-25
Sample Cell, 10-mL	6/pkg 24276-06

Optional Reagents

Drinking Water Quality Control Standard, mixed parameter, inorganics containing fluoride, nitrate, sulfate, and phosphate	500 mL.....28330-49
Hydrochloric Acid Standard Solution, 6.0 N (1:1).....	500 mL..... 884-49
Phosphate Pretreatment Powder Pillows	50/pkg..... 14501-99
Phosphate Standard Solution, 1 mg/L as PO_4^{3-}	500 mL..... 2569-49
Phosphate Standard Solution, 3 mg/L as PO_4^{3-}	946 mL.....20597-16

Optional Reagents, continued

Phosphate Standard Solution, Voluette Ampule, 50 mg/L as PO_4^{3-} , 10-mL.....	16/pkg.....171-10
Sodium Hydroxide Standard Solution, 5.0 N.....	100-mL MDB..... 2450-32
Wastewater Quality Control Standard, mixed parameter, effluent.....	500 mL.....28332-49
Wastewater Quality Control Standard, mixed parameter, influent.....	500 mL..... 28331-49
Water, deionized.....	4 L..... 272-56

Phosphorus, Reactive, continued

Optional Apparatus

Description	Unit	Cat. No.
AccuVac [®] Snapper	each	24052-00
Ampule Breaker Kit	each	21968-00
pH Indicator Paper, 1 to 11 pH	5 rolls/pkg	391-33
sens <i>ion</i> [™] 1 Basic Portable pH Meter, with electrode	each	51700-10
Pipet, 2-mL, serological	each	532-36
Pipet, TenSette [®] , 0.1 to 1.0 mL	each	19700-01
Pipet Tips, for 19700-01	50/pkg	21856-96
Pipet Filler, safety bulb	each	14651-00

Replacement Parts

Batteries, alkaline, AAA	4/pkg	46743-00
Instrument Cap/Light Shield	each	59548-00
Instrument Manual	each	59576-88

Digestion for Total Phosphorus

(Also called Organic and Acid Hydrolyzable)

Method 8190

For water, wastewater, and seawater.

Acid Persulfate Digestion Method* USEPA accepted for reporting wastewater analysis**

Measuring Hints

- If the expected total phosphate concentration is greater than 3 mg/L, dilute the sample and apply the appropriate dilution factor to the results.

* Adapted from *Standard Methods for the Examination of Water and Wastewater*.

** Procedure is equivalent to USEPA Method 365.2 and Standard Method 4500-P B, 5 and PE.

Digestion for Total Phosphorus, continued

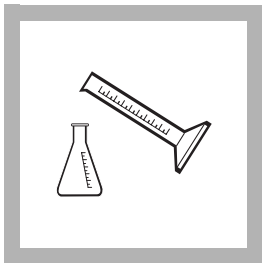

1. Measure 25 mL of sample into a 50-mL Erlenmeyer flask using a graduated cylinder.

Note: *Rinse all glassware with 1:1 Hydrochloric Acid Solution. Rinse again with deionized water.*

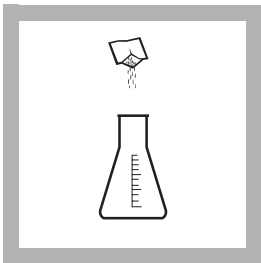

2. Add the contents of one Potassium Persulfate Powder Pillow. Swirl to mix.

Note: *If only inorganic acid hydrolyzable phosphorus (not total including organic) is desired, omit the Potassium Persulfate.*

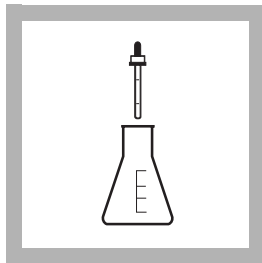

3. Add 2.0 mL of 5.25 N Sulfuric Acid Solution.

Digestion for Total Phosphorus, continued



4. Place the flask on a hot plate. Boil gently for 30 minutes.

Note: *Sample should be concentrated to less than 20 mL for best recovery. After concentration, maintain the volume near 20 mL by adding small amounts of deionized water. Do not exceed 20 mL.*



5. Cool the sample to room temperature.

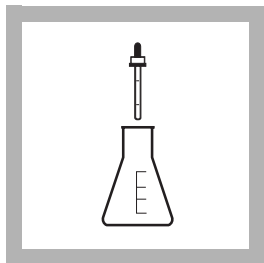

6. Add 2.0 mL of 5.0 N Sodium Hydroxide Solution. Swirl to mix.

Note: *Use the 1-mL calibrated dropper provided.*

Digestion for Total Phosphorus, continued

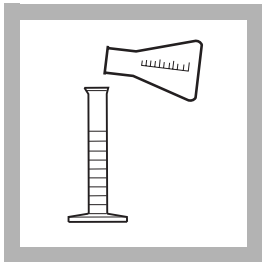

7. Pour the sample into a 25-mL graduated cylinder. Return the volume to 25 mL. Proceed with the reactive phosphorus test ([page 1–15](#)).

Note: Use deionized water rinsings from the flask to adjust the volume.

Note: Results of the reactive phosphorus test at this point will include the organic phosphate plus the orthophosphate and the acid-hydrolyzable (condensed) phosphate. The organic phosphate concentration is determined by subtracting results of an acid hydrolyzable phosphorus test from this result. See note in [step 2 on page 1–32](#).

Sampling and Storage

Collect samples in plastic or glass bottles that have been acid-cleaned with 1:1 Hydrochloric Acid Solution and rinsed with deionized water. Do not use commercial detergents containing phosphate for cleaning glassware used in this test.

Analyze samples immediately after collection for best results. If prompt analysis is impossible, preserve samples up to 48 hours by storing at or below 4 °C. Warm to room temperature before testing.

Interferences

For turbid samples, use 50 mL of sample and double the reagent quantities. Use 25 mL of the digested sample to zero the instrument in the reactive phosphorus procedure. This compensates for any color or turbidity destroyed by this procedure. For alkaline or highly buffered samples, it may be necessary to add more acid in [step 3](#) to drop the pH of the solution below 1.

Digestion for Total Phosphorus, continued

Summary of Method

Phosphates present in organic and condensed inorganic forms (meta-, pyro- or other polyphosphates) must be converted to reactive orthophosphate before analysis. Pretreatment of the sample with acid and heat provides the conditions for hydrolysis of the condensed inorganic forms. Organic phosphates are converted to orthophosphate by heating with acid and persulfate. Organically bound phosphates are determined indirectly by subtracting the result of an acid hydrolyzable phosphorus test (without potassium persulfate) from the total phosphorus result (with potassium persulfate).

This procedure must be followed by the reactive phosphorus (orthophosphate) analysis method for determination of the phosphorus content of the sample. If the Ascorbic Acid (PhosVer[®] 3 Reagent) Method is used to measure the reactive phosphorus, this method is U. S. Environmental Protection Agency (USEPA) accepted for National Pollutant Discharge Elimination System (NPDES) reporting.

The following reagents and apparatus are required in addition to those required for the reactive phosphorus test.

Digestion for Total Phosphorus, continued

Reagents and Apparatus

Required Reagents

Description	Unit	Cat. No.
Potassium Persulfate		
Powder Pillows	100/pkg.....	2451-99
Sodium Hydroxide Solution, 5.0 N.....	100 mL* MDB.....	2450-32
Sulfuric Acid Solution, 5.25 N	100 mL* MDB.....	2449-32

Required Apparatus

Cylinder, graduated, 25-mL.....	each.....	508-40
Flask, Erlenmeyer, 50-mL	each.....	505-41

Optional Reagents

Hydrochloric Acid, 6 N.....	500 mL.....	884-49
Sodium Hydroxide Solution, 5.0 N.....	1 L	2450-53
Water, deionized.....	4 L	272-56

* Contact the manufacturer for larger sizes.

Digestion for Total Phosphorus, continued

Optional Apparatus

Description	Unit	Cat. No.
Cylinder, graduated, 50-mL	each	508-41
Flask, Erlenmeyer, 125-mL.....	each	505-43
Hot Plate, 4-inch diameter, 120 Vac.....	each	12067-01
Hot Plate, 4-inch diameter, 240 Vac.....	each	12067-02
Pad, cooling, 4 x 4 inches.....	each	18376-00
pH Indicator Paper, 1 to 11 pH.....	5 rolls/pkg	391-33
sens <i>ion</i> TM 1 Basic Portable pH Meter, with electrode.....	each	51700-10

Phosphonates (0.1–2.5 to 1–125 mg/L)

For water, wastewater, and seawater.

Method 8007

Persulfate UV Oxidation Method* • Clean glassware with 1:1

Hydrochloric Acid Solution (Cat. No. 884-49), followed by a distilled water rinse. Do not clean glassware with commercial detergent.

- Wear UV safety goggles while the UV lamp is on.
- Do not handle the UV lamp surface. Fingerprints will etch the glass. Wipe the lamp with a soft, clean tissue between samples.
- The digestion in step 6 is normally completed in less than 10 minutes. However, contaminated samples or a weak lamp can cause incomplete phosphate conversion. Check conversion efficiency by running a longer digestion and seeing if the readings increase.

Note: *The Pocket Colorimeter II is designed to measure solutions contained in sample cells. DO NOT dip the meter in the sample or pour the sample directly into the cell holder.*

* Adapted from Blystone, P., Larson, P., *A Rapid Method for Analysis of Phosphonate Compounds*, International Water Conference, Pittsburgh, PA, Oct. 26-29, 1981.

Phosphonates, continued

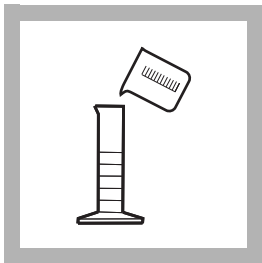

1. Choose a sample size from [Table 1](#) . Use a graduated cylinder or pipet to measure the sample.

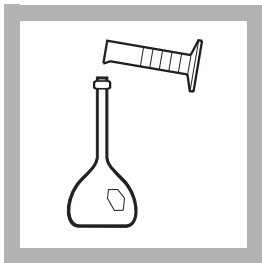

2. Pour the sample into a plastic 50-mL volumetric flask. Dilute to the mark with deionized water. Cap and invert to mix.

Table 1

Expected Concentration (mg/L PO_4)	Sample (mL)
0-2.5	50
0-5	25
0-12.5	10
0-25	5
0-125	1

Phosphonates, continued

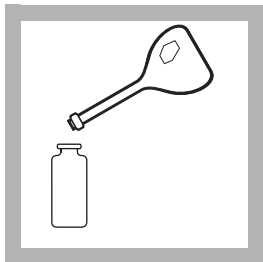

3. Fill a mixing bottle to the shoulder with the diluted sample (approximately 25 mL).



4. Fill a sample cell with 10 mL of diluted sample (the blank) from the flask.



5. Add the contents of one Potassium Persulfate for Phosphonate Powder Pillow to the mixing bottle. Swirl to mix.

Phosphonates, continued

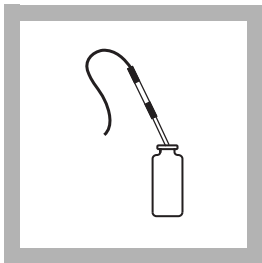

6. Insert the ultraviolet lamp into the mixing bottle. Turn the power supply on and digest the sample for 10–15 minutes.

Note: *Phosphonates are converted to orthophosphate during digestion.*

Caution: *Wear UV safety goggles while the lamp is on.*

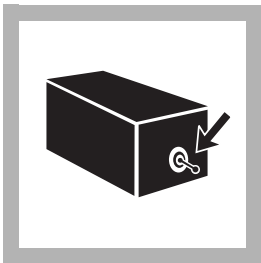

7. After digestion, turn the power supply off and remove the lamp.

Caution: *Mixing bottle may be hot if long digestion periods are used.*



8. Fill a 10-mL sample cell to the 10-mL mark with the digested sample.

Note: *Cool the sample to room temperature if it is hot from digestion.*

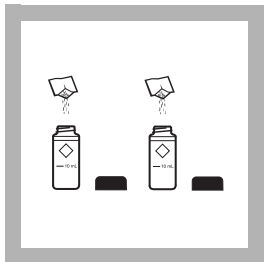

9. Add the contents of one PhosVer® 3 Powder Pillow to each sample cell (blank and sample). Immediately cap and shake 10–15 seconds.

Note: A blue color will form if phosphate is present; both sample and blank may develop color.



10. Wait at least 2 minutes (but no more than 10 minutes) for full color development before completing steps 11–15.

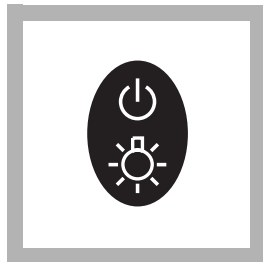

11. Press the **POWER** key to turn the meter on. The arrow should indicate channel 2.

Note: See [page 2–4](#) for information on selecting the correct channel.

Phosphonates, continued

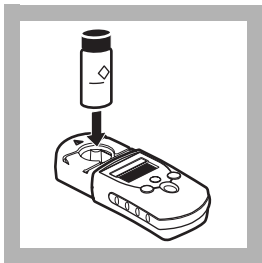

12. Place the blank into the cell holder with the diamond mark facing the keypad.

Note: *Wipe off any liquid or finger prints.*

Cover the sample cell with the instrument cap.

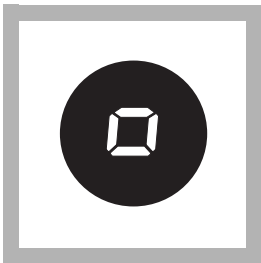

13. Press: **ZERO/SCROLL**

The meter will show “- - - -” followed by “0.0”.

Remove the blank.

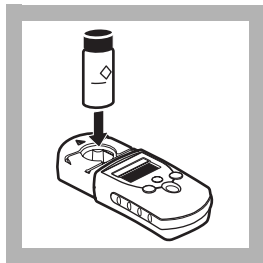

14. Place the prepared sample into the cell holder.

Note: *Wipe off any liquid or finger prints.*

Cover the sample cell with the instrument cap.

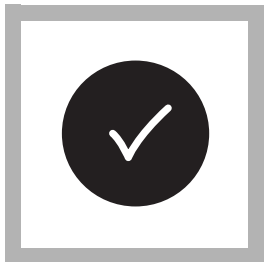

15. Press READ/ENTER.

The meter will show “- - -”, followed by the results in mg/L phosphate. Multiply this value by the appropriate multiplier in [Table 2](#) to obtain the true phosphate concentration.

Table 2

Sample Volume	Multiplier
50	0.1
25	0.2
10	0.5
5	1.0
1	5.0

Phosphonates, continued

Results may be expressed in terms of active phosphonic acid by multiplying the result by the appropriate conversion factor in [Table 3](#) .

Table 3

Phosphonate Type	Conversion Factor
Bayhibit AM PBTC	2.84
Dequest 2000, Wayplex NTP, ATMP	1.050
Dequest 2010, Wayplex HEDPA-60, HEDP	1.085
Dequest 2041, EDTMPA	1.148
Dequest 2051, HMDTMPA	1.295
Dequest 2060, DETPMPA	1.207

Active phosphonic acid (mg/L) = phosphate value x conversion factor.

Sampling and Storage

Collect samples in plastic or glass bottles that have been cleaned with 1:1 Hydrochloric Acid Solution and rinsed with deionized water. Do not use commercial detergents containing phosphate for cleaning glassware used in phosphate analysis.

Best results are obtained when samples are analyzed as soon as possible after collection. If prompt analysis is impossible, preserve samples up to 48 hours by storing at or below 4 °C. Warm to room temperature before testing.

Accuracy Check

Standard Additions Method

1. Using a graduated cylinder, measure the appropriate amount of sample from [Table 1](#) on [page 1–40](#) into each of three 50-mL volumetric flasks.
2. Snap the neck off a Phosphate Voluette® Ampule Standard Solution, 50 mg/L PO_4^{3-} .

Phosphonates, continued

3. Use a TenSette[®] Pipet to add 0.1 mL, 0.2 mL, and 0.3 mL of standard, respectively, to the three water samples. Dilute to the 50-mL mark with deionized water and mix each thoroughly.
4. Analyze each standard addition sample as described in the procedure. The displayed phosphate concentration should increase 1.0 mg/L for each 0.1 mL of standard added (due to a dilution factor of 10 in the calibration).

Standard Solution Method

1. Fill a 10-mL sample cell to the 10-mL mark with a 2 mg/L phosphate standard (see below) in place of the digested sample used in [step 8](#) on [page 1–42](#).
2. Use deionized water as the blank.
3. Follow the procedure beginning with [step 8](#) on [page 1–42](#).
4. The displayed result should be 20.0 mg/L (due to a dilution factor of 10 in the calibration).

Standard Calibration Adjust Method

To perform a standard calibration adjustment using the 2.0 mg/L phosphate standard (= 20 mg/L due to the dilution), or using an alternative concentration, see [Standard Calibration Adjust on page 2–13](#)

Preparation of 2 mg/L Phosphate Standard Solution

1. Using a volumetric class A pipet, transfer 2 mL of a 100 mg/L Phosphate Standard Solution to a 100-mL volumetric flask.
2. Dilute to the 100-mL mark with deionized water. Stopper and invert to mix.

Interferences

Aluminum	100 mg/L
Arsenate	Interferes at all levels
Benzotriazole	10 mg/L
Bicarbonate	1000 mg/L
Bromide	100 mg/L

Phosphonates, continued

Calcium	5000 mg/L
CDTA	100 mg/L
Chloride	5000 mg/L
Chromate	100 mg/L
Copper	100 mg/L
Cyanide	100 mg/L (Increase the UV digestion to 30 minutes.)
Diethanoldithio- carbamate	50 mg/L
EDTA	100 mg/L
Iron	200 mg/L
Nitrate	200 mg/L
NTA	250 mg/L
Orthophosphate	15 mg/L

Phosphonates, continued

Phosphites and organophos-phorus compounds	React quantitatively. Meta- and polyphosphates do not interfere.
Silica	500 mg/L
Silicate	100 mg/L
Sulfate	2000 mg/L
Sulfide	Interferes at all levels
Sulfite	100 mg/L
Thiourea	10 mg/L
Highly buffered samples or extreme sample pH	May exceed the buffering capacity of the reagents and require sample pretreatment.

Summary of Method

In the phosphonate procedure, a UV-catalyzed oxidation converts phosphonate to orthophosphate. The orthophosphate is then quantified using the PhosVer 3 method.

Phosphonates, continued

Reagents and Apparatus

Required Reagents

Phosphonate Reagent Set (100 tests)24297-00

Includes:

(2) PhosVer[®] 3 Phosphate Reagent Powder Pillows

(1) Potassium Persulfate Powder Pillows

Required Apparatus

Description	Unit	Cat. No.
Bottle, mixing	6/pkg	439-06
Cylinder, graduated, 5-mL.....	each	508-37
Flask, volumetric, 50-mL, Nalge	each	14060-41
Goggles, UV Safety	each	21134-00
UV Lamp with Power Supply, 115 Vac	each	20828-00
—OR—		
UV Lamp with Power Supply, 230 Vac.....	each	20828-02
Sample Cells, 10-mL.....	6/pkg	24276-06

Optional Reagents

Description	Unit	Cat. No.
Hydrochloric Acid Standard Solution, 6.0 N (1:1).....	500 mL.....	884-49
Phosphate Standard Solution, 100 mg/L as PO ₄ ³⁻	946 mL.....	14368-16
Phosphate Standard Solution, Voluette™ Ampule, 50 mg/L as PO ₄ ³⁻ , 10-mL	16/pkg.....	171-10
Sodium Hydroxide Standard Solution, 5.0 N.....	100-mL MDB.....	2450-32
Water, deionized.....	4 L.....	272-56

Optional Apparatus

Description	Unit	Cat. No.
Ampule Breaker Kit	each.....	21968-00
Cylinder, graduated, 10-mL	each.....	508-38
Cylinder, graduated, 25-mL.....	each.....	508-40
Flask, volumetric, Class A, 100-mL	each.....	14574-42
pH Indicator Paper, 1 to 11 pH.....	5 rolls/pkg.....	391-33
Pipet, 2-mL, serological	each.....	532-36
Pipet, volumetric, Class A, 2-mL	each.....	14515-36
Pipet, Tensette, 0.1–1.0 mL.....	each.....	19700-01
Replacement Tips for 19400-01	50/pkg.....	21856-96

Phosphonates, continued

Optional Apparatus, continued

Description	Unit	Cat. No.
UV Lamp (for ac power supply).....	each	26710-00
UV lamp (for 9 V battery power supply).....	each	26708-00
UV lamp power supply for 26708-00 lamp (requires 9 V batteries).....	each	26706-00

Replacement Parts

Batteries, alkaline, AAA	4/pkg	46743-00
Battery, alkaline, 9 V (for 26706-00)	each	50110-00
Instrument Cap/light shield.....	each	59548-00
Instrument Manual.....	each	59576-88





Section 2

Instrument Manual

Instrument Operation

Key Functions

Key	Description	Function
	POWER	On/Off/Backlight To turn on the backlight, turn on the instrument, then press and hold the power key until the backlight turns on. Press and hold again to turn off the backlight. This key functions the same in all instrument modes and ranges.
	ZERO/SCROLL	In measurement mode, sets the instrument to zero. In menu mode, scrolls through menu options. Also scrolls numbers when entering or editing a value.
	READ/ENTER	In measurement mode, initiates sample measurement. In menu mode, selects a menu option. When entering numbers, moves one space to the right and executes the function when the entry is complete.

Instrument Operation, continued

Key	Description	Function
	MENU	Enter/Exit the menu mode Press and hold for approximately 5 seconds to enter user-entered method mode.

Menu Selections

Press the **MENU** key to access the menu selections.

Switching Ranges

1. Press the **MENU** key. The display will show “SEL”. A flashing arrow indicates the current range.
2. Press the **READ/ENTER** key to toggle between ranges.
3. Press **MENU** again to accept and exit back to the measurement screen.

Setting the Time

1. Press the **MENU** key, then press the **ZERO/SCROLL** key until the display shows a time in the “00:00” format.

2. Press **READ/ENTER**. The digit to be edited will flash.
3. Use the **ZERO/SCROLL** key to change the entry, then press **READ/ENTER** to accept and advance to the next digit. The time is entered in 24-hour format.

Recalling Stored Measurements

1. Press the **MENU** key, then press the **ZERO/SCROLL** key until the display shows RCL. The instrument automatically stores the last 10 measurements.
2. In RCL, press **READ/ENTER** to recall the stored measurements, beginning with the most recent measurement taken. The meter stores the measurement number as 01 (most recent) through 10 (oldest), the time the measurement was taken, and the measurement value. The **ZERO/SCROLL** key allows for selection of a specific measurement by number. The **READ/ENTER** key scrolls through all stored data points.



Battery Installation

Figure 1 on page 2–7 provides an exploded view of battery installation.

1. Unhook the latch and remove the battery compartment cover. The polarities are shown on the battery holder.
2. Place the four batteries provided with the instrument in the holder as indicated and replace the battery compartment cover. The display will show the software version number (e.g., “P 1.6”) after correct battery installation.

When replacing discharged batteries, always replace the complete set of four alkaline batteries. **Rechargeable batteries are not recommended** and cannot be recharged in the instrument.

Note: *The Low Battery icon will appear on the display when the batteries have 10% battery life remaining. The battery icon will flash when the batteries are too low to complete measurements. See [Instrument Keys and Display on page 1–11](#).*

Figure 1 Battery Installation

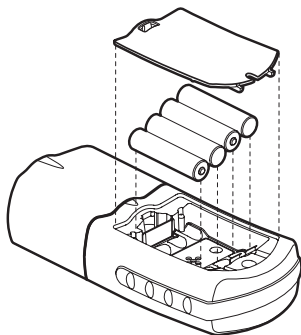

Error Codes

When the instrument cannot perform the function initiated by the operator, an error message will appear in the display. Refer to the appropriate message information below to determine what the problem is and how it can be corrected. Resolve error messages in the order that they appear on the display. Service Centers are listed in [page 2–37](#).

Error Messages

1. E-0 No Zero (User mode)

Error occurs when trying to read a standard in the user calibration mode before setting the meter to zero.

- Zero the instrument on an appropriate blank.

2. E-1 Ambient Light Error

There is too much light present to take a valid measurement.

- Verify instrument cap is correctly seated.
- If the problem persists, contact a Service Center ([page 2–37](#)).

Error Codes, continued

3. E-2 LED Error

The LED (light source) is out of regulation.

- Replace batteries.
- Verify LED lights up (inside the cell holder) when the **READ/ENTER** or **ZERO/SCROLL** key is pressed.
- If the problem persists, contact a Service Center ([page 2–37](#)).

Note: When an E-1 or E-2 error occurs on a measurement, the display will show “_._.” (The decimal place is determined by the chemistry.) If the E-1 or E-2 error occurs while zeroing the meter, the meter will require the user to re-zero.

4. E-3 Standard Adjust Error

The value obtained on the prepared standard exceeds the adjustment limits allowed for the standard concentration, or the concentration of the standard is outside the concentration range allowed for standard calibration adjust.

- Prepare the standard and rerun according to the procedure.
- Prepare a standard at or near the recommended concentrations given in the procedure.
- Verify that the concentration of the standard has been entered correctly.

- If the problem persists, contact a Service Center ([page 2–37](#)).

5. E-6 Abs Error (User mode)

Indicates that the absorbance value is invalid, or indicates an attempt to make a curve with less than two points.

- Enter or measure the absorbance value again.
- If the problem persists, contact a Service Center ([page 2–37](#)).

6. E-7 Standard Value Error (User mode)

Standard concentration is equal to another standard concentration that is already entered.

- Enter the correct standard concentration.
- If the problem persists, contact a Service Center ([page 2–37](#)).

7. E-9 Flash Error

The meter is unable to save data.

- If the problem persists, contact a Service Center ([page 2–37](#)).

Error Codes, continued

8. Underrange—flashing number below stated test range

- Verify instrument cap is correctly seated.
- Check zero by measuring a blank. If error recurs, re-zero the instrument.
- If the problem persists, contact a Service Center ([page 2–37](#)).

Note: See *Maximum/Minimum Displayed Value on page 2–26* for more information.

9. Overrange—flashing number above stated test range

Note: *Flashing value will be 10% over the upper test limit.*

- Check for light blockage.
- Dilute and retest sample.

Note: See *Maximum/Minimum Displayed Value on page 2–26* for more information.

Standard Calibration Adjust

The Pocket Colorimeter™ II instrument is factory-calibrated and ready for use without user calibration. Use of the factory calibration is recommended unless the user is required to generate a calibration. The Standard Calibration Adjust can be used to meet regulatory requirements.

This feature allows the factory default calibration curve to be adjusted with a known standard. Use the standard described in the procedure.

1. Place a blank in the meter (in measurement mode). Press **ZERO/SCROLL**.
2. Place the reacted standard in the meter. Press **READ/ENTER**.
3. Press **MENU**, then press **ZERO/SCROLL** until the display shows “SCA”.
4. Press **READ/ENTER** to display the standard calibration adjust value.
5. Press **READ/ENTER** to adjust the curve to the displayed value. The meter will return to the measurement mode and the Calibration Adjusted icon will appear in the display window.

If an alternate concentration is used, or if a standard concentration is not given:

6. Repeat steps 1–4.

Standard Calibration Adjust, continued

7. Press **ZERO/SCROLL** to access the Edit function, then press **READ/ENTER** to begin editing. The digit to be edited will flash. Use the **ZERO/SCROLL** key to change the entry, then press **READ/ENTER** to accept and advance to the next digit.

When the last digit is entered, press **READ/ENTER** and the meter will adjust the curve to the value entered. The meter will return to measurement mode and the Calibration Adjusted icon will appear in the display window.

To turn off Standard Calibration Adjust (SCA):

1. Press **MENU**.
2. Press **ZERO/SCROLL** until “SCA” appears in the display.
3. Press **READ/ENTER**, then press **ZERO/SCROLL** until “Off” appears in the display.
4. Press **READ/ENTER** to turn off SCA.

Note: Perform another standard calibration adjust to turn SCA on again.

Note: For meters with factory-calibrated ranges or methods, Standard Calibration Adjust (SCA) will be disabled when a user-entered method is programmed into the meter. To turn SCA back on, restore the meter to factory default calibration. See Retrieving the Factory Calibration on page 2–25.

User-Entered Calibration

Overview

The Pocket Colorimeter™ II will accept a user-prepared calibration curve. The curve can extend from 0 to 2.5 absorbance. A user-prepared calibration curve may be entered into any channel that does not contain a factory-programmed curve. These channels are labeled “abs” on instruments having a single factory calibration or are labeled “1” and “2” on the uncalibrated single wavelength instruments. Any chemistry that can be run at the instrument wavelength may be user-entered in these channels.

Using prepared standard solutions that cover the range of interest, the meter generates a calibration curve by calculating the straight-line segments between each standard entered. A calibration curve may be entered using the keypad. Factory-entered calibration curves may also be recalculated or adjusted using the same procedure.

To enter the user-entered calibration mode, press the **MENU** key and hold it down until the display shows “USER” (about 5 seconds), followed by “CAL”. Press **ZERO/SCROLL** to scroll through the options.

*Note: If the meter does not display USER followed by CAL after pressing the **MENU** key, the factory calibration cannot be modified on this channel.*

User-Entered Calibration, continued

- CAL—Used to enter and edit standard values and measure absorbance values, or review the existing calibration.
- Edit—Used to enter and edit standard values and absorbance values with the keypad or review the existing calibration. Used to enter a predetermined calibration curve.
- dFL—Used to return the instrument back to the default factory calibration. User-entered calibrations are stored upon exit from the calibration or edit modes.

Note: To return to factory settings, following the instructions in [Retrieving the Factory Calibration on page 2–25](#).

If the instrument is shut off or loses power during data entry, all edits will be lost. Automatic shut-off in user-entered calibration entry mode is 60 minutes.

CAL and Edit Submenus

In CAL mode, standard values are entered and absorbance values are measured. In Edit mode, standard and absorbance values are entered.

- To select CAL from the User menu, press **READ/ENTER**.
- To select Edit from the User menu, press **ZERO/SCROLL** and **READ/ENTER**.

- Once in the CAL or Edit option, press the **READ/ENTER** key to navigate through each option.

Note: Press **ZERO/SCROLL** to quickly scroll through each option.

Calibration Procedure Using Prepared Standards

Note: *Deionized water or a reagent blank can be used to zero during the calibration procedure. Calibrations generated with deionized water as the zero will give less accurate results if the reagent blank is significantly more turbid or colored than deionized water. Use the deionized water or the reagent blank as the zero concentration point (SO) in the following calibration procedure.*

1. Turn on the instrument and select the range to be calibrated. An arrow at the top of the display will point to the selected range. To change ranges, press the **MENU** key, then use the **READ/ENTER** key to toggle between ranges 1 and 2. Press **MENU** again to return to measurement mode.
2. Follow the procedure for the chemical method to be calibrated. Prepare a reagent blank (if needed) and a standard solution. Allow the color to develop fully.

User-Entered Calibration, continued

3. Insert the reagent blank or deionized water into the meter and cover with the cap. Press the **ZERO/SCROLL** key. The meter will display “- - -”, followed by “0.000”. This initializes (zeroes) the meter.
4. Press the **MENU** key and hold it down until the display shows “USER”, followed by “CAL”. Press **READ/ENTER** to enter the calibration mode.
5. In factory-calibrated meters, S0 will appear in the display.

Note: When recalibrating a factory-calibrated meter or range, RES (resolution) cannot be changed.

6. In uncalibrated meters or meters with ranges labeled Abs, “RES” will appear. Press **ZERO/SCROLL** to review the current resolution (decimal placement). Press **ZERO/SCROLL** again to accept the current resolution. To change the resolution, press **READ/ENTER**, then **ZERO/SCROLL** to change the resolution. Press **READ/ENTER** to accept the new resolution. “S0” will appear on the display.
7. Press the **READ/ENTER** key again, then enter the blank value.

*Note: Press the **READ/ENTER** key to move from digit to digit. Use the **ZERO/SCROLL** key to change the number.*

8. After completing entry of the blank value, press the **READ/ENTER** key. The display will show “A0”.

User-Entered Calibration, continued

9. Insert the reagent blank or deionized water into the cell holder. Cover the blank with the instrument cap.
10. Press the **READ/ENTER** key. The meter will measure and display the absorbance value for “S0”.
11. Remove the sample blank. Press the **ZERO/SCROLL** key. “S1” will appear. Press the **READ/ENTER** key, then enter the first standard value.

*Note: Press the **READ/ENTER** key to move from digit to digit. Use the **ZERO/SCROLL** key to change the number.*

12. After completing entry of the first standard value, press the **READ/ENTER** key. The display will show “A1”.
13. Insert the first reacted standard solution into the cell holder. Cover the prepared standard with the instrument cap.
14. Press the **READ/ENTER** key. The meter will measure and display the absorbance value for S1.
15. The calibration is complete with two points. If additional standards are required, press **ZERO/SCROLL** until “Add” appears on the display. Repeat steps 11–14 to enter additional standards.

User-Entered Calibration, continued

16. Press the **MENU** key twice to exit and accept the changes. The instrument will use this calibration to determine the displayed concentration of future sample measurements.

Entering a Predetermined Calibration Curve

Note: Entering a predetermined calibration curve requires at least two data pairs. Each data pair requires a concentration value and the absorbance value for the given concentration. Up to 10 data pairs may be entered. This procedure uses the Edit mode.

1. Turn on the instrument and select the range to be calibrated. An arrow at the top of the display will point to the selected range. To change ranges, press the **MENU** key, then use the **READ/ENTER** key to toggle between ranges 1 and 2. Press **MENU** again to return to measurement mode.
2. Press the **MENU** key and hold it down until the display shows “USER”, followed by “CAL”. Press **ZERO/SCROLL** to scroll to EDIT. Press **READ/ENTER**.
3. In uncalibrated meters or in Abs range, “RES” will appear. Press **ZERO/SCROLL**. To change the resolution (decimal placement), press **READ/ENTER**. Press **ZERO/SCROLL** to select the new resolution, then press **READ/ENTER** to accept. “S0” will appear on the display.

User-Entered Calibration, continued

4. Enter the concentration value and absorbance value of the first data pair (S0, A0).
5. To enter the S0 value, press **READ/ENTER**. Use the **ZERO/SCROLL** key to select the numerical value, then press the **READ/ENTER** key to accept the entry and advance to the next decimal place. Repeat this sequence until the S0 concentration value is entered.
6. After editing the S0 value, press **READ/ENTER** to accept. "A0" will appear on the display.
7. To enter the absorbance value for S0, press the **READ/ENTER** key to go to entry mode. Use the **ZERO/SCROLL** key to select the numerical value, then press the **READ/ENTER** key to accept the entry and advance to the next decimal place. Repeat this sequence until the absorbance value for S0 is entered.
8. After entering A0, press **READ/ENTER** to accept. "S1" will appear on the display.
9. Repeat steps 5 through 8 for each standard value and absorbance value pair in the calibration curve

*Note: After A1 is entered, Add will appear in the display. If additional data pairs are to be entered, press **READ/ENTER** and continue with step 9.*

User-Entered Calibration, continued

10. When all the calibration data has been entered, press **MENU** twice to return to the measurement mode.

Editing a User-entered or Factory Calibration Curve

1. Press the **MENU** key and hold it down until the display shows “USER”, followed by “CAL”. Press **ZERO/SCROLL** until EDIT appears.

*Note: If the meter does not display USER followed by CAL after pressing the **MENU** key, the factory calibration cannot be modified on this channel.*

2. Press the **READ/ENTER** key to enter Edit mode. In factory-calibrated meters, “S0” will appear in the display.

Note: When editing a factory-calibrated meter or range, RES (resolution) cannot be changed.

*Note: When RES or S0 appears in the display, press **ZERO/SCROLL** to quickly scroll to the data to be edited.*

3. In uncalibrated meters or in Abs range, “RES” will appear. Press **ZERO/SCROLL** to review the current resolution. Press **ZERO/SCROLL** again to accept the displayed resolution. To change the resolution (decimal placement), press

User-Entered Calibration, continued

READ/ENTER. Press **ZERO/SCROLL** to select the new resolution, then press **READ/ENTER** to accept. "S0" will appear on the display.

4. Press **READ/ENTER**. The current concentration value for S0 will appear on the display.
5. To edit the S0 value, press **READ/ENTER**. Use the **ZERO/SCROLL** key to select the numerical value, then press the **READ/ENTER** key to accept the entry and advance to the next decimal place. Repeat this sequence until the S0 concentration value is entered.
6. After editing the S0 value, press **READ/ENTER** to accept. "A0" will appear on the display.
7. To edit the absorbance value for S0, press the **READ/ENTER** key to go to entry mode. Use the **ZERO/SCROLL** key to select the numerical value, then press the **READ/ENTER** key to accept the entry and advance to the next decimal place. Repeat this sequence until the absorbance value for S0 is entered.
8. After editing A0, press **READ/ENTER** to accept. "S1" will appear on the display.
9. Repeat steps 4 through 8 for each standard value and absorbance value pair in the calibration curve.

User-Entered Calibration, continued

10. When all calibration data has been reviewed or edited, “ADD” will appear in the display.
11. Press **READ/ENTER** to add more calibration points, or press **MENU** twice to return to the measurement mode.

Note: When a factory calibration curve has been edited, the “calibration adjust” icon will appear in the display.

Exiting the Calibration Routine

Exit the calibration routine by pressing the **MENU** key to return to measurement mode. The instrument uses the last completed user-entered calibration or the factory calibration if no user-entered calibration has been completed.

Deleting Calibration Points

1. Select the range containing user-entered calibration points. See [Switching Ranges on page 2–4](#).
2. Press and hold the **MENU** key until “USER”, then “CAL” appears. Press **READ/ENTER**.

Note: Calibration points can also be deleted in Edit mode.

User-Entered Calibration, continued

3. Press **ZERO/SCROLL** to select the point to delete (e.g., S0 or S1 or S2). Press **READ/ENTER**.
4. The left digit will flash. Press **ZERO/SCROLL** until “dEL” appears. (“dEL” will appear after the numeral 9.)
5. Press **READ/ENTER** to delete. Repeat for all points to be deleted.
Note: The minimum number of valid points is two. For example, if five points have been entered, three can be deleted using this feature.
6. Press **MENU** to return to the measurement mode.

Retrieving the Factory Calibration

1. Select the range to restore factory default calibration. See [Switching Ranges on page 2–4](#).
2. Press and hold the **MENU** key until “USER”, then “CAL” appears.
*Note: If the meter does not display USER followed by CAL after pressing the **MENU** key, the factory calibration cannot be modified on this channel.*
3. Press the **ZERO/SCROLL** key to find dFL.

User-Entered Calibration, continued

4. Press the **READ/ENTER** key to select dFL and restore the instrument to the factory default calibration.

Note: *For meters with factory-calibrated ranges or methods, Standard Calibration Adjust (SCA) will be disabled when a user-entered method is programmed into the meter. To turn SCA back on, restore the meter to factory default calibration.*

Maximum/Minimum Displayed Value

In meters with absorbance (Abs) ranges, the maximum displayed value and minimum displayed value is related to the value of the standards entered in a user calibration.

Measurements that exceed the minimum or maximum standards entered in the user calibration will return a flashing number indicating “underrange” or “overrange”. See *Error Codes* (page 2–12) for more information.

Example 1

For a calibration with the following standards:

User-Entered Calibration, continued

S0=0.000

S1=1.000

Maximum Displayed Value	1.000
Minimum Displayed Value	0.000

Example 2

For a calibration with the following standards:

S0=1.00

S1=2.00

S2=4.00

Maximum Displayed Value	4.00
Minimum Displayed Value	1.00

For Hach-calibrated programs, the maximum and minimum displayed values always equal the factory-calibrated values and cannot be changed.

Certification

Hach Company certifies this instrument was tested thoroughly, inspected, and found to meet its published specifications when it was shipped from the factory.

The Pocket Colorimeter™ II instrument has been tested and is certified as indicated to the following instrumentation standards:

EMC Immunity:

Per **89/ 336/ EEC EMC: EN 61326: 1998** (Electrical Equipment for measurement, control and laboratory use—EMC requirements). Supporting test records by Hach Company, certified compliance by Hach Company.

Standard(s) include:

IEC 1000-4-2: 1995 (EN 61000-4-2: 1995) Electro-Static Discharge Immunity (Criteria B)

IEC 1000- 4- 3: 1995 (EN 61000- 4- 3: 1996) Radiated RF Electro- Magnetic Field Immunity (Criteria A)

Additional Immunity Standard(s) include:

ENV 50204: 1996 Radiated Electromagnetic Field from Digital Telephones

Certification, continued

(Criteria A) Radio Frequency Emissions:

Per **89/ 336/ EEC EMC: EN 61326: 1998** (Electrical Equipment for measurement, control and laboratory use—EMC requirements) “Class B” emission limits.

Supporting test records from Hach EMC Test Facility, certified compliance by Hach Company.

Additional Radio Frequency Emissions Standard(s) include:

EN 55022 (CISPR 22), Class B emissions limits.

Canadian Interference-causing Equipment Regulation, IECS-003, Class A:

Supporting test records from Hach EMC Test Facility, certified compliance by Hach Company.

This Class A digital apparatus meets all requirements of the Canadian Interference-causing Equipment Regulations.

Cet appareil numérique de la classe A respecte toutes les exigences du Règlement sur le matériel brouilleur du Canada.

FCC Part 15, Class “A” Limits: Supporting test records from Hach EMC Test Facility, certified compliance by Hach Company.

This device complies with Part 15 of the FCC Rules. Operation is subject to the following two conditions:

(1) This device may not cause harmful interference, and (2) This device must accept any interference received, including interference that may cause undesired operation. Changes or modifications to this unit not expressly approved by the party responsible for compliance could void the user's authority to operate the equipment.

This equipment has been tested and found to comply with the limits for a Class A digital device, pursuant to Part 15 of the FCC Rules. These limits are designed to provide reasonable protection against harmful interference when the equipment is operated in a commercial environment. This equipment generates, uses, and can radiate radio frequency energy and, if not installed and used in accordance with the instruction manual, may cause harmful interference to radio communications. Operation of this equipment in a residential area is likely to cause harmful interference, in which case the user will be required to correct the interference at his own expense. The following techniques of reducing the interference problems are applied easily.

Certification, continued

1. Remove power from the Pocket Colorimeter instrument by removing one of its batteries to verify that it is or is not the source of the interference.
2. Move the Pocket Colorimeter instrument away from the device receiving the interference.
3. Reposition the receiving antenna for the device receiving the interference.
4. Try combinations of the above.



GENERAL INFORMATION

At Hach Company, customer service is an important part of every product we make.

With that in mind, we have compiled the following information for your convenience.

How to Order

By Telephone:

6:30 a.m. to 5:00 p.m. MST
Monday through Friday
(800) 227-HACH (800-227-4224)

By FAX:

(970) 669-2932 (Hach Loveland)

By Mail:

Hach Company
P.O. Box 389
Loveland, Colorado 80539-0389 U.S.A.

For order information by E-mail:

orders@www.hach.com

Information Required:

- Hach account number (if available)
- Billing address
- Shipping address
- Your name and phone number
- Purchase order number
- Catalog number
- Brief description or model number
- Quantity

How to Order, continued

Technical and Customer Service (USA only)

Hach Technical and Customer Service Department personnel are eager to answer questions about our products and their use and to take your orders. Specialists in analytical methods, they are happy to put their talents to work for you.

Call 1-800-227-4224 or E-mail techhelp@hach.com.

International Customers

Hach maintains a worldwide network of dealers and distributors. To locate the representative nearest you, send E-mail to intl@hach.com or call (970) 669-3050.

In Canada

Hach Instrument Service Centre, Winnipeg, Manitoba, Canada

Telephone: (204) 632-5598; (800) 665-7635

FAX: (204) 694-5134

Repair Service

Authorization must be obtained from Hach Company before sending any items for repair. Please contact the Hach Service Center serving your location.

In the United States:

Hach Company
100 Dayton Avenue
Ames, Iowa 50010
(800) 227-4224 (USA only)
FAX: (515) 232-3835

Latin America, Caribbean, Africa,
Far East, Indian Subcontinent:
Hach Company World Headquarters
P.O. Box 389
Loveland, Colorado 80539-0389 U.S.A.
Telephone: (970) 669-3050
FAX: (970) 669-2932
E-mail: intl@hach.com.

Canada:

Hach Sales & Service Canada Ltd.
1313 Border Street, Unit 34
Winnipeg, Manitoba R3H 0X4
(800) 665-7635 (Canada only)
Telephone: (204) 632-5598
FAX: (204) 694-5134
E-mail: canada@hach.com

Europe, the Middle East,
or Mediterranean Africa:
HACH Company, c/o
Dr. Bruno Lange GmbH & CO. KG
Willstätterstr. 11
40549 Düsseldorf, Germany
Telephone: +49/(0)211/52 88-0
FAX: +49/(0)211/52 88-134

Warranty

Hach Company warrants this product to the original purchaser against any defects that are due to faulty material or workmanship for a period of **two years from date of shipment**.

In the event that a defect is discovered during the warranty period, Hach Company agrees that, at its option, it will repair or replace the defective product or refund the purchase price, excluding original shipping and handling charges. Any product repaired or replaced under this warranty will be warranted only for the remainder of the original product warranty period.

This warranty does not apply to consumable products such as chemical reagents; or consumable components of a product, such as, but not limited to, lamps and tubing.

Contact Hach Company or your distributor to initiate warranty support. Products may not be returned without authorization from Hach Company.

Limitations

This warranty does not cover:

- damage caused by acts of God, natural disaster, labor unrest, acts of war (declared or undeclared), terrorism, civil strife or acts of any governmental jurisdiction
- damage caused by misuse, neglect, accident or improper application or installation
- damage caused by any repair or attempted repair not authorized by Hach Company
- any product not used in accordance with the instructions furnished by Hach Company
- freight charges to return merchandise to Hach Company
- freight charges on expedited or express shipment of warranted parts or product
- travel fees associated with on-site warranty repair

Warranty, continued

This warranty contains the sole express warranty made by Hach Company in connection with its products. All implied warranties, including without limitation, the warranties of merchantability and fitness for a particular purpose, are expressly disclaimed.

Some states within the United States do not allow the disclaimer of implied warranties and if this is true in your state the above limitation may not apply to you. This warranty gives you specific rights, and you may also have other rights that vary from state to state.

This warranty constitutes the final, complete, and exclusive statement of warranty terms and no person is authorized to make any other warranties or representations on behalf of Hach Company.

Limitation of Remedies

The remedies of repair, replacement or refund of purchase price as stated above are the exclusive remedies for the breach of this warranty. On the basis of strict liability or under any other legal theory, in no event shall Hach Company be liable for any incidental or consequential damages of any kind for breach of warranty or negligence.