

FDO[®] 925



FDO[®] 925-P



FDO[®] 925

FDO[®] 925-P

OPTICAL D.O. SENSOR

Distributed By: Camlab Ltd
Unit 24, Norman Way Industrial Estate
Over, Cambridge, CB24 5WE, United Kingdom
T: +44 (0) 1954 233 110 E: sales@camlab.co.uk





For the most recent version of the manual, please visit
<hyperlink>www.si-analytics.com.

Copyright

© 2015, WTW GmbH

Reproduction in whole - or even in part - is prohibited without the
express written permission of WTW GmbH, Weilheim.

Printed in Germany.

FDO® 925 - Contents

1	Overview	4
1.1	Structure and function	4
1.2	Recommended fields of application	5
2	Measuring / Operation	6
2.1	General information on the handling of the sensor cap ..	6
2.2	Commissioning	6
2.3	Opening and closing the IDS plug connection (FDO® 925-P) 7	
2.4	Measuring	8
2.5	Function check and user calibration	8
2.6	Storage	9
3	Maintenance, cleaning, replacement	10
3.1	General maintenance instructions	10
3.2	Exchanging the sensor cap	11
3.3	Cleaning the sensor	12
3.4	Checking the zero point of the sensor	13
4	What to do if... ..	14
5	Technical data	15
6	Wear parts and accessories	18

1 Overview

1.1 Structure and function

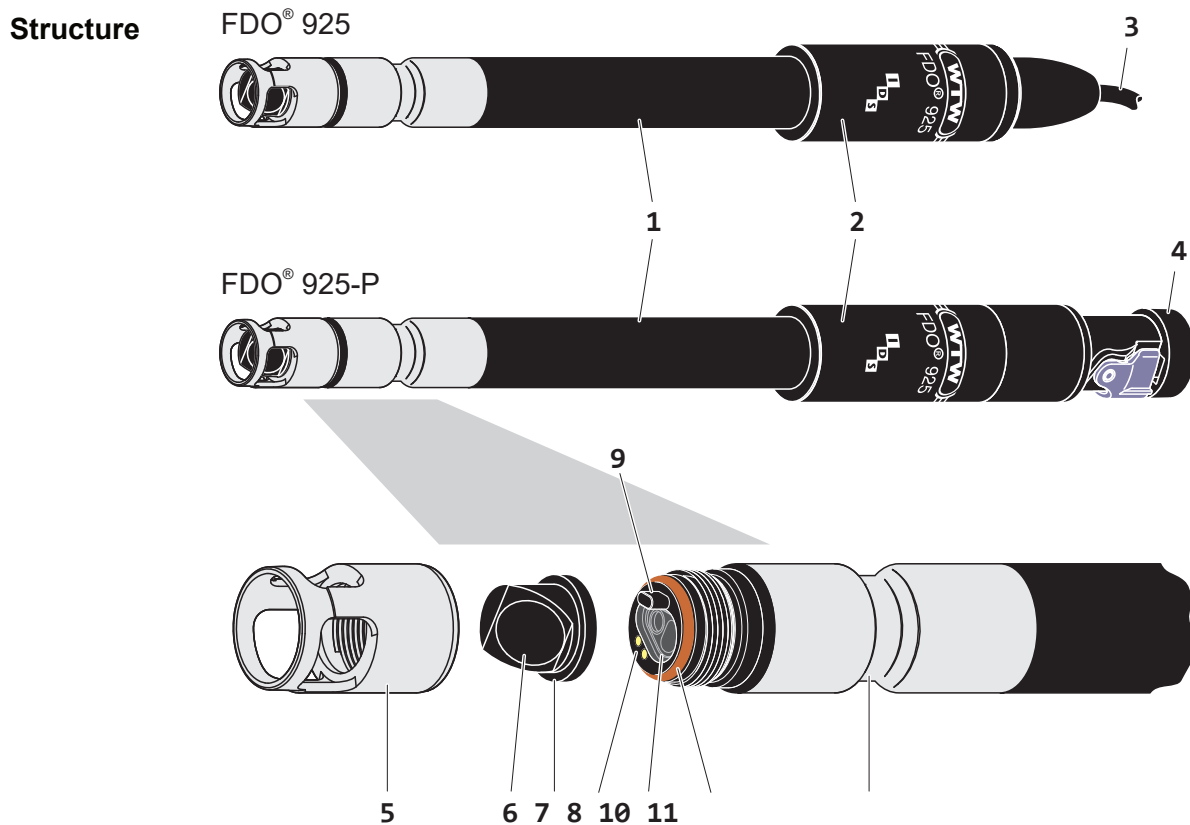

1	Shaft
2	Connecting head with active sensor electronics
3	Connection cable (FDO® 925)
4	IDS plug (FDO® 925-P)
5	Protective hood, with connection for RZ 300 stirrer (accessory)
6	Sensor membrane
7	SC-FDO® 925 sensor cap with memory chip
8	Gold-plated contacts for the memory chip of the sensor cap
9	Locking device
10	Measurement window
11	O-ring
12	Thermistor enclosure with temperature sensor

Sensor cap with memory chip

A memory chip is integrated in the sensor cap. The following data are stored on the memory chip:

- Type designation of the sensor cap
- Series number
- Data of the factory calibration or user calibration

Intelligent membrane (IQMC technology)

For each membrane, the individual calibration values are determined by a factory calibration process and stored to the memory chip of the sensor cap, ensuring maximum accuracy over the whole lifetime of the sensor.

Automatic sensor recognition

The data of the sensor and sensor cap is recalled by the meter when the sensor is connected and is used for measurement and for measured value documentation. The calibration data are stored in the sensor cap. Thus, the calibration is automatically retained if the sensor or meter are exchanged.

The digital transmission technique guarantees the failure-free communication with the meter even with long connection cables.

Firmware update

You can update the firmware of the IDS sensor using your meter. Details on the firmware update are given in the current operating manual of your meter.

The current operating manual of your meter and the firmware update for the sensor are available on the Internet under www.WTW.com.

1.2 Recommended fields of application

Recommended fields of application

- On site measurements in rivers, lakes and wastewater
- Applications in water laboratories
- BOD measurements

2 Measuring / Operation

2.1 General information on the handling of the sensor cap

Despite its exterior robustness, the sensor is a high precision optical instrument. Therefore, you should take the following precautions when dealing with the FDO® 925:

- Please do not touch the sensor membrane with your fingers
- Avoid any great mechanical stress of the sensor membrane (pressure, scratches).

2.2 Commissioning

Scope of delivery

- D.O. sensor FDO® 925 with sensor cap
- Check and storage vessel, FDO® Check
- Operating manual

Preparing the sensor for measurement

FDO® 925	Connect the sensor to the meter. The sensor is immediately ready to measure.
FDO® 925-P	Connect the sensor to a free IDS sensor plug-in position of the multi parameter probe or to an IDS connection of the meter. To open and close the IDS plug-in position please note the section 2.3 OPENING AND CLOSING THE IDS PLUG CONNECTION (FDO® 925-P). The sensor is immediately ready to measure. Connection cables in different lengths to connect the FDO® 925-P sensor to the meter are listed in chapter 6 WEAR PARTS AND ACCESSORIES.

2.3 Opening and closing the IDS plug connection (FDO® 925-P)



This section only applies to the IDS plug variant, FDO® 925-P.

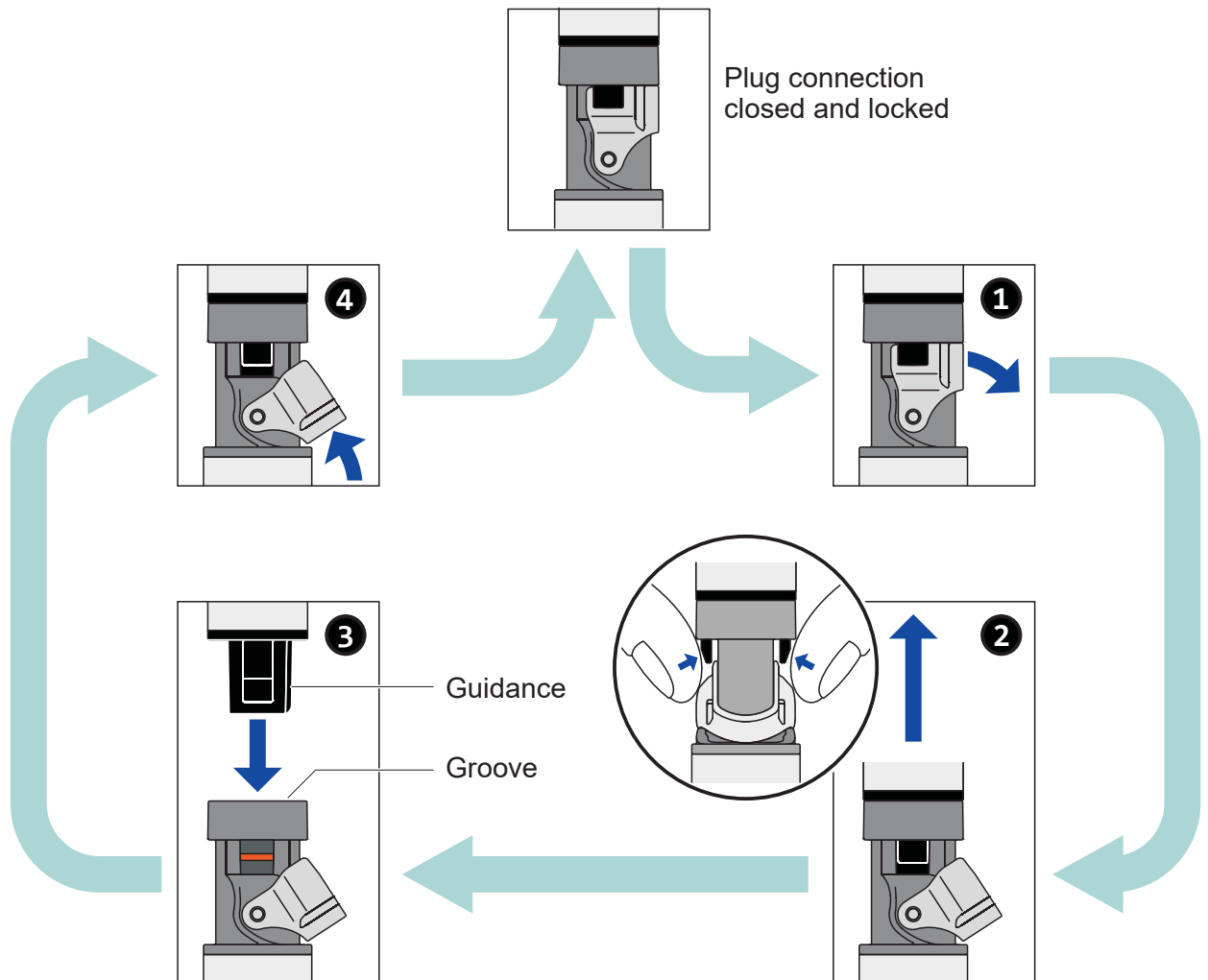

Opening the plug connection

- If necessary, clean the plug connection
- Open the locking device (step 1)
- Use your thumb and index finger to press the clips of the connector together, and pull the connector out of the plug (step 2).

Closing the plug connection

- Make sure that the plug connection is completely dry and clean.
- Align the guidance of the connector with the groove in the plug and insert the connector in the unlocked plug until it catches (step 3).
- Close the locking device (step 4).

2.4 Measuring

Minimum depth of immersion

Observe the required minimum immersion depth (see chapter 5 TECHNICAL DATA).

Incident flow

The FDO[®] 925 D.O. sensor enables precise measurements without any incident flow.

However, an incident flow of the sensor membrane improves the responding behavior of the sensor (see chapter 5 TECHNICAL DATA). The incident flow can be provided in different ways, e. g.:

- The flow of the water to be measured is sufficient (aeration tank, water pipe, stream)
- Slowly pull the sensor through the water by hand (lake, container), or
- Use a flow aid such as a magnetic stirrer with stirring device (see chapter 6 WEAR PARTS AND ACCESSORIES)

2.5 Function check and user calibration

Factory calibration

The FDO[®] 925 is factory calibrated. In the recommended application (see page 5), the measuring characteristics of the sensor cap remain stable for the specified service life. Thus, a user calibration is not usually required.

When does a check or user calibration make sense?

A function check or user calibration can be useful in the following special cases:

- If the measured values appear to be implausible and it is assumed that the service life of the sensor cap is over
- Routinely within the framework of the company quality assurance.

Check- or calibration medium

The check and user calibration take place in water vapor-saturated air. The suitable conditions are easily provided with the aid of the check and calibration vessel, FDO[®] Check. For this purpose, moisten the sponge inside the vessel. Then insert the sensor in the vessel as far as it will go. The sensor membrane must be clean and dry for this.

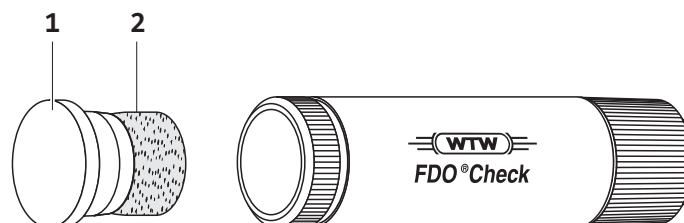

Moisten the sponge:

- Remove the cap (1).
- Take out the sponge (2), wet it, then slightly squeeze it out.
- Insert the sponge again and close the calibration and storage vessel with

the lid.

After inserting the sensor, wait for the temperatures of the sensor and calibration vessel to adjust.



The steps of the check or user calibration are described in detail in the operating manual of the meter.

2.6 Storage

Always store the sensor in the check and storage vessel (FDO[®] Check) at a temperature in the range 0 ... 50 °C (32 ... 122 °F).

3 Maintenance, cleaning, replacement

3.1 General maintenance instructions

Handling of the sensor cap

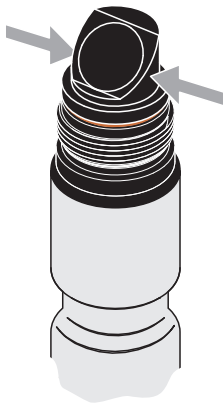

Despite its exterior robustness, the sensor is a high precision optical instrument. Therefore, special care should be taken when doing any maintenance or cleaning work:

- Dirt and moisture under the sensor cap can affect the functioning and shorten the service life of the sensor cap. Therefore, make sure the working environment is clean and dry prior to removing the sensor cap.
- Please do not touch the outer sensor membrane with your fingers. Touch the sensor cap at the sides only (arrows in figure on the left).
- Avoid any great mechanical stress of the sensor membrane (pressure, scratches).
- Exposure to light, particularly daylight, of the interior of the sensor cap will, by-and-by, affect the measurement characteristics and shorten the service life of the sensor cap. Therefore, the interior of the sensor cap should not be exposed to direct sunlight. Avoid any exposure to light that exceeds the extent required for necessary maintenance and cleaning activities. Store dismantled sensor caps in a light-protected environment only.

3.2 Exchanging the sensor cap



Before removing the sensor cap, observe the general maintenance instructions in section 3.1.

To exchange the sensor cap, proceed as follows:

Removing the sensor cap

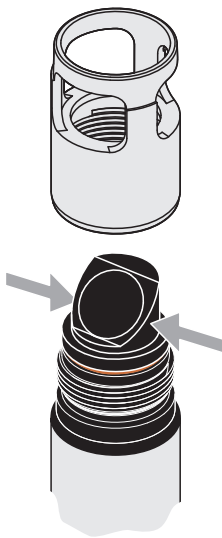

- | | |
|----|--|
| 1. | Pull the sensor out of the sample. |
| 2. | Clean the outside of the sensor (see section 3.3.1). |
| 3. | Unscrew the protective hood from the sensor by hand. |
| 4. | Thoroughly clean and dry the sensor head once again. |
| 5. | Grasp the sensor cap on the sides (arrows in figure on the left) and remove it by pulling it away from the sensor in a <u>straight</u> upward direction. |

Caution:

Do not push any tools or other sharp objects between the sealing surfaces. This would damage the sealing surfaces and sealing ring.

Mounting the sensor cap

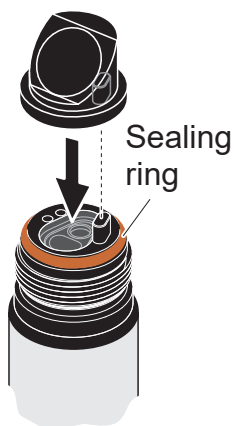

- | | |
|-----|---|
| 6. | Check the front surface of the sensor for absolute cleanness and clean it if necessary (see section 3.3.2). |
| 7. | Thoroughly clean the thread of the protective hood. |
| 8. | Check the sealing ring for intactness and correct position. The sealing ring has to be replaced if it is damaged. |
| 9. | Aim the sensor head upwards and place the new sensor cap on the sensor. The locking device on the sensor head must be inserted into the receptacle on the inside of the sensor cap (see figure on the left). |
| 10. | Put the protective hood on the sensor head and screw it tight by hand <u>as far as it will go</u> . A gap of approx. 0.8 mm remains between the protective hood and sensor. The sensor is immediately ready to measure. |

3.3 Cleaning the sensor

3.3.1 Exterior cleaning

Dirt on the sensor can affect the measuring characteristics. Biological deposits for example, consume oxygen and can, when occurring on the sensor membrane, impair the responding behavior and cause values that are too low. Therefore, we recommend regular visual inspections and exterior cleaning as necessary.

Pay attention to the following points for cleaning:

- First, thoroughly rinse the sensor with tapwater to remove loosely adhering dirt.
- Rough dirt on the sensor shaft can be brushed off with a soft brush. **Attention:** Do not use the brush in the area of the sensor membrane. Risk of damage!
- The sensor cap including the sensor membrane should be wiped with a soft and moist microfiber cloth.
- In the case of persisting dirt you can add some household washing-up liquid to the tapwater. **Attention:** Never use any alcohol for cleaning!

3.3.2 Interior cleaning of sensor cap and sensor head

If moisture or dirt have penetrated under the sensor cap, e.g. because the sensor cap is damaged, you can make the sensor ready for operation again as follows:

NOTE

Only use nonabrasive, alcohol-free detergents, as otherwise the optical surfaces could be damaged.

1.	Remove the sensor cap (see section 3.2).
2.	Clean the sensor head and sensor cap: <ul style="list-style-type: none"> – Rinse all inner surfaces with tapwater – Remove contamination containing fat and oil with warm water and household washing-up liquid – Then rinse all inner surfaces with deionized water
3.	Pat dry all surfaces with a clean, lint free cloth.
4.	Allow the sensor and sensor cap to dry completely at a dry location so moisture can evaporate even from corners difficult to access. When doing, so protect the inside of the sensor cap from light.
5.	Put the sensor cap on (see section 3.2).



If the sensor cap is visibly damaged it has to be replaced.

3.4 Checking the zero point of the sensor

There are two methods to check the zero point of the sensor:

- Measurement in a nitrogen atmosphere (recommended method)
- Measurement in a sodium sulfite solution according to DIN EN 25814/ISO 5814.

Test criterion

The sensor is OK if the measuring instrument displays < 0.5 % D.O. saturation after 15 minutes.

4 What to do if...

Error symptom	Cause	Remedy
No temperature value or D.O. value	– No connection between meter and D.O. sensor	– Establish connection between meter and D.O. sensor
	– Cable defective	– Return the D.O. sensor
Measured value too high or too low or error message, <i>Error</i>	– Coating on sensor cap	– Clean the outside of the sensor (see section 3.3.1)
	– Membrane damaged	– Exchange the sensor cap
	– Service life of the sensor cap over	– Check the sensor – Replace the sensor cap as necessary (see section 3.2)
	– Dirt inside the sensor cap and sensor head. – Protective hood not properly tightened. – Sensor cap untight or defective.	– Dismantle the sensor cap – Clean the insides of the sensor cap and sensor head (see section 3.3.2) – Mount the sensor cap correctly and tighten the protective hood as far as it will go (see section 3.2) – Replace a defective sensor cap as necessary
Incorrect temperature display	– The temperature sensor is not immersed deep enough in the measuring solution	– Observe the minimum immersion depth
	– Temperature sensor defective	– Return the D.O. sensor
Error message, <i>no cap</i>	– No sensor cap put on	– Clean the sensor head and sensor cap
	– Sensor cap not recognized	– Return the D.O. sensor
	– Sensor cap defective	– Replace the sensor cap

5 Technical data

General features	Measuring principle	Optical measurement based on photoluminescence.
	Temperature sensor	Integrated NTC 30 (30 k Ω at 25 °C / 77 °F)

Dimensions (in mm)

FDO® 925:

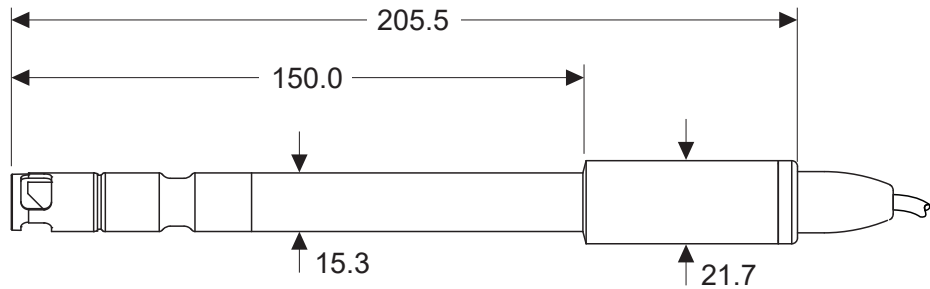

FDO® 925-P:

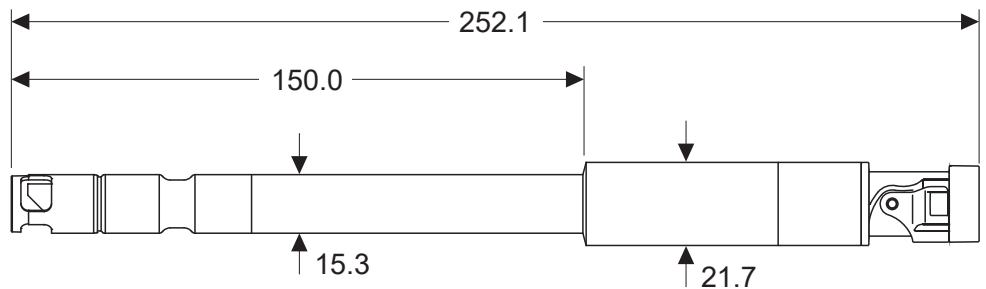

Weights	FDO® 925	180 g (with 3 m cable)
	FDO® 925-P	107 g
	FDO® Check	58 g
Materials	Shaft	POM
	Connection head	POM
	Sensor cap	PVC, silicone and PMMA
	Sensor head	POM, PV and PMMA
	Sensor head - sensor cap contacts	Brass, gold-plated
	Thermistor housing	VA steel 1.4571
	Protective hood	VA steel 1.4571
	Seals	FPM (Viton)

Connection cable (FDO® 925)	Lengths	1.5 or 3 m
	Diameter	4.3 mm
	Smallest allowed bend radius	Fixed installation: 20 mm Flexible use: 60 mm
	Plug type	Socket, 4 pins
IDS plug (FDO® 925-P)	Connection type	4-pole, watertight plug connection with lock, reverse polarity protected
	Materials	<ul style="list-style-type: none"> ● Synthetic materials: Glass fiber reinforced Noryl, TPU, TPC-ET, POM, PEEK, PBT ● O-ring: FPM ● Contacts gold-plated
Pressure resistance	Sensor with connection cable	IP 68 (1 x 10 ⁶ Pa or 10 bar)
	Cable plug (FDO® 925)	IP 67 (when plugged in)
<p>The FDO® 925 meets the requirements according to article 3(3) of the 97/23/EC directive ("Pressure equipment directive").</p>		
Measurement conditions	Measuring ranges at 20 °C (68 °F)	0 ... 20 mg/l D.O. 0 ... 200 % D.O. saturation 0 ... 400 mbar D.O. partial pressure
	Temperature range	0 ... 50 °C (32 ... 122 °F)
	Max. admissible overpressure	1 x 10 ⁶ Pa (10 bar)
	Immersion depth	min. 6 cm max. 100 m (depending on the cable length)
	Operating position	any
	Approach flow	not required
	Storage conditions	Recommended storing method
Storage temperature		0 ... 50 °C (32 ... 122 °F)

Characteristic data on delivery	Accuracy of D.O. measurement at 20 °C (68 °F) in air-saturated water	± 1.5 %
	Zero signal	≤ 0.02 mg/l O ₂ ≤ 0.2 % O ₂ saturation ≤ 0.4 mbar O ₂ partial pressure
	Response time at 20 °C (68 °F) in stirred solution	t ₉₀ (90 % of the final value display after) < 30 s t ₉₅ (95 % of the final value display after) < 45 s t ₉₉ (99 % of the final value display after) < 60 s
	Response time of temperature measurement	t ₉₉ (99 % of the final value display after) < 60 s
	Precision of temperature measurement	± 0.2 K
	Working life of the sensor cap	Min. 1 year with authorized use

6 Wear parts and accessories

Wear parts and maintenance equipment	Description	Model	Order no.
	Replacement sensor cap	SC-FDO® 925	201 310
	Replacement protective hood	ADA FDO®/RZ	201 312

General accessories	Description	Model	Order no.
	Calibration and storage vessel	FDO® Check	201 311
	Magnetic stirrer	Oxi-Stirrer 300	203 810
	Stirring accessory - provides a constant, defined flow to the sensor, in conjunction with the Oxi-Stirrer 300. The stirring accessory is put on the protective hood.	RZ 300	203 824
	Funnel set - for BOD measurements in Winkler bottles	TS 19	205 710
	Karlsruhe bottle - suitable for BOD measurement	KF 12	205 700
	Fixing ring, recommended for measurements in Karlsruhe bottles	FR 19	205 712
	Flow-through accessory - for pressure-free D.O. measurement with flow-through quantities from 25 to 65 ml/min.	D 201	203 730

Accessories for FDO® 925-P (IDS plug variant)	Description	Model	Order no.
	IDS connection cable, 1.5 m	AS/IDS-1.5	903 850
	IDS connection cable, 3 m	AS/IDS-3	903 851
	IDS connection cable, 6 m	AS/IDS-6	903 852
	IDS connection cable, 10 m	AS/IDS-10	903 853
	IDS connection cable, 15 m	AS/IDS-15	903 854
	IDS connection cable, 20 m	AS/IDS-20	903 855
	IDS connection cable, 25 m	AS/IDS-25	903 856
	IDS connection cable, 40 m	AS/IDS-40	903 857
	IDS connection cable, 60 m	AS/IDS-60	903 858
	IDS connection cable, 100 m	AS/IDS-100	903 859
	Blind plug for IDS plug	BPO/IDS 900	908 371



Further accessories are listed in the price list of the WTW catalog "Laboratory and field instrumentation".

Xylem |'zīləm|

- 1) The tissue in plants that brings water upward from the roots;
- 2) a leading global water technology company.

We're 12,500 people unified in a common purpose: creating innovative solutions to meet our world's water needs. Developing new technologies that will improve the way water is used, conserved, and re-used in the future is central to our work. We move, treat, analyze, and return water to the environment, and we help people use water efficiently, in their homes, buildings, factories and farms. In more than 150 countries, we have strong, long-standing relationships with customers who know us for our powerful combination of leading product brands and applications expertise, backed by a legacy of innovation.

For more information on how Xylem can help you, go to www.xyleminc.com

Distributed By: Camlab Ltd
Unit 24, Norman Way Industrial Estate
Over, Cambridge, CB24 5WE, United Kingdom
T: +44 (0) 1954 233 110 E: sales@camlab.co.uk



Wissenschaftlich-Technische Werkstätten GmbH

Dr.-Karl-Slevogt-Straße 1
D-82362 Weilheim
Germany

Tel: +49 881 183-0
Fax: +49 881 183-420
E-Mail: info@wtw.com
Internet: www.wtw.com