

WATERPROOF 800 pH/CONDUCTIVITY/TDS METER



OPERATING INSTRUCTIONS

PT 146 WATERPROOF 800 pH/CONDUCTIVITY/TDS METER (pH/Conductivity/Total Dissolved Solids/Temperature Meter)

Preface

This manual serves to explain the use of the Waterproof pH/Conductivity/TDS meter. It functions in two ways, firstly as a step by step guide to help you to operate the meter. Secondly, it serves as a handy reference guide. It is written to cover as many anticipated applications of the Waterproof pH/Conductivity/TDS meter as possible. If there are doubts in the use of the Waterproof 800 meter, please do not hesitate to contact the nearest Palintest Authorised Distributor.

Palintest cannot accept any responsibility for damage or malfunction to the meter caused by improper use of the instrument.

Remember to fill in the guarantee card and mail it back to your authorized distributor or Palintest Ltd.

The information presented in this manual is subject to change without notice as improvements are made, and does not represent a commitment on the part of Palintest Ltd.

Copyright © Feb 2000. All rights reserved.

TABLE OF CONTENTS

1	INTRODUCTION	4
2	DISPLAY AND KEYPAD FUNCTIONS	5
2.1	<i>Display</i>	5
2.2	<i>Keypad</i>	6
3	PREPARATION	7
3.1	<i>Inserting the Batteries</i>	7
3.2	<i>Probe Information</i>	8
4	CALIBRATION	10
4.1	<i>Important Information on Meter Calibration</i>	10
4.2	<i>Preparing the Meter for Calibration</i>	11
4.3	<i>pH Calibration</i>	11
4.4	<i>Conductivity Calibration</i>	14
4.5	<i>TDS Calibration</i>	17
4.6	<i>Calibration with Conductivity Standard and TDS Factor</i>	18
4.7	<i>Temperature Calibration</i>	19
5	MEASUREMENT	20
5.1	<i>Taking pH Measurements</i>	20
5.2	<i>Taking Conductivity or TDS Measurement</i>	23
6	HOLD FUNCTION	29
7	ADVANCED SETUP FUNCTIONS	30
7.1	<i>Advanced SETUP Mode Overview</i>	32
7.2	<i>P1.0: Viewing previous pH Calibration Data</i>	35
7.3	<i>P2.0: Viewing pH Electrode Data</i>	36
7.4	<i>P3.0: pH Measurement Configuration</i>	37
7.5	<i>P4.0: Resetting to Factory Default Settings (pH)</i>	41
7.6	<i>P5.0: Viewing Previous Conductivity Calibration Data</i>	42
7.7	<i>P6.0: Viewing Conductivity Probe Data</i>	43
7.8	<i>P7.0: Conductivity or TDS Measurement Configuration</i>	44
7.9	<i>P8.0 Temperature</i>	48
8	PROBE CARE AND MAINTENANCE	51
8.1	<i>pH Electrode Care</i>	51
8.2	<i>Conductivity Electrode</i>	53
9	TROUBLE SHOOTING GUIDE	54
10	ERROR MESSAGES	55
11	SPECIFICATIONS	56
12	ACCESSORIES	57
13	ADDENDUM 1: CONDUCTIVITY TO TDS CONVERSION FACTORS	58
14	ADDENDUM 2: CALCULATING TDS CONVERSION FACTORS	59
15	ADDENDUM 3: CALCULATING TEMPERATURE COEFFICIENTS	60
16	ADDENDUM 4: METER FACTORY DEFAULT SETTINGS	62
17	WARRANTY AND RETURN OF ITEMS	63

1 INTRODUCTION

Thank you for selecting a Palintest Waterproof Portable Meter. This meter is a microprocessor-based instrument that is designed to be handy capable of allowing one-hand operation. It is capable of measuring pH, Conductivity, TDS and Temperature. It is completely WATERPROOF --- and it FLOATS!

This meter has many user-friendly features ---- all of which are completely accessible through the water-resistant membrane keypad. Your meter includes a conductivity electrode (cell constant $K = 1.0$) with built-in temperature sensor (Order Code: PT 146), pH electrode (EC-FE72522-01B) and batteries. Please read this manual thoroughly before operating your meter.



Figure 1: Palintest PC 300 Meter

2 DISPLAY AND KEYPAD FUNCTIONS

2.1 Display

The LCD has a primary and secondary display :

- The primary display shows the measured pH or conductivity.
- The secondary display shows the measured temperature.

The display also shows error messages, keypad functions and program functions.
See Figure 2 :-

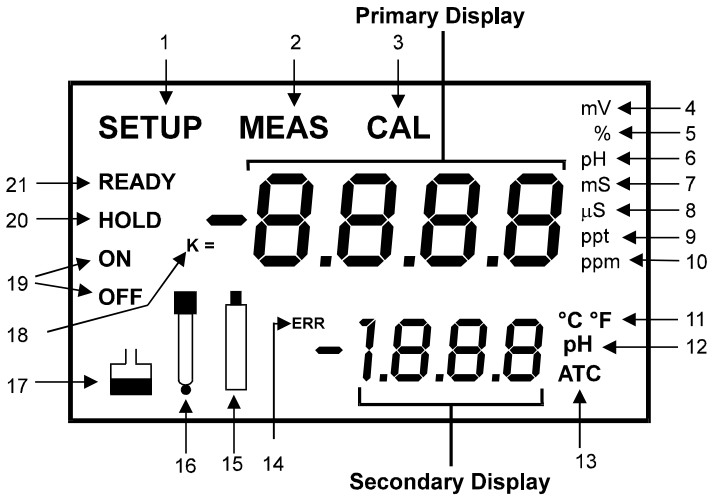

Figure 2: Full LCD Screen

- | | | |
|-------------------------------|--|------------------------------------|
| 1. SETup mode indicator | 8. micro-siemens indicator | 15. Low battery indicator |
| 2. MEASurement mode indicator | 9. parts per thousand indicator | 16. Probe indicator |
| 3. CALibration indicator | 10. parts per million indicator | 17. Calibration solution Indicator |
| 4. mV indicator | 11. Temperature indicator | 18. Cell constant indicator |
| 5. % indicator | 12. pH indicator | 19. ON / OFF indicator |
| 6. pH measurement indicator | 13. Automatic Temperature Compensation indicator | 20. HOLD indicator |
| 7. milli-siemens indicator | 14. ERRor indicator | 21. READY indicator |

2.2 Keypad

The large membrane keypad makes the instrument easy to use. Each button, when pressed, has a corresponding graphic indicator on the LCD. See Figure 1. Some buttons have several functions depending on its mode of operation.

Key	Function
ON/OFF	Powers on and shuts off the meter. When you switch on the meter, the meter starts up in the mode that you last switched off from. For example, if you shut the meter off in conductivity measurement mode, the meter will be in conductivity measurement mode when you switch the meter on.
HOLD	Freezes the measured reading. To activate, press HOLD while in measurement mode. To release, press HOLD again.
MODE	Selects the measurement parameter. Press MODE to toggle between pH or TDS or conductivity measurement mode.
CAL/MEAS	Toggles between Calibration and Measurement mode. <ol style="list-style-type: none"> 1. If you are in pH measurement mode, press CAL/MEAS to enter pH calibration mode. 2. If you are in conductivity measurement mode, press CAL/MEAS to enter conductivity calibration mode. 3. If you are in TDS measurement mode, press CAL/MEAS to enter TDS measurement calibration mode. While in SETUP sub-menu, pressing CAL/MEAS once takes you out to the SETUP main menu and pressing CAL/MEAS second time takes you directly into the measurement mode.
ENTER / RANGE	<i>ENTER function:</i> Press to confirm values in Calibration mode and to confirm selections in SETUP mode. <i>RANGE function (for conductivity & TDS measurements only):</i> Press to enter manual ranging function. The MEAS indicator blinks while in manual ranging function.
▲ / ▼	<u>In Calibration mode:</u> During conductivity and TDS calibration, press to scroll through calibration values. <u>In SETUP mode:</u> Press to scroll through the setup subgroup programs.
SETUP	Takes you into the SETUP mode. This mode lets you customize meter preference and defaults, view calibration, electrode offset data, adjust for temperature coefficient and normalization temperature.

3 PREPARATION

3.1 Inserting the Batteries

Four AAA batteries are included with your meter.

- 1 Use a Philips screwdriver to remove the two screws holding the battery cover. See Figure 3 below.
- 2 Remove battery cover to expose batteries.
- 3 Insert batteries. Follow the diagram inside the cover for correct polarity.
- 4 Replace the battery cover into its original position using the two screws removed earlier.

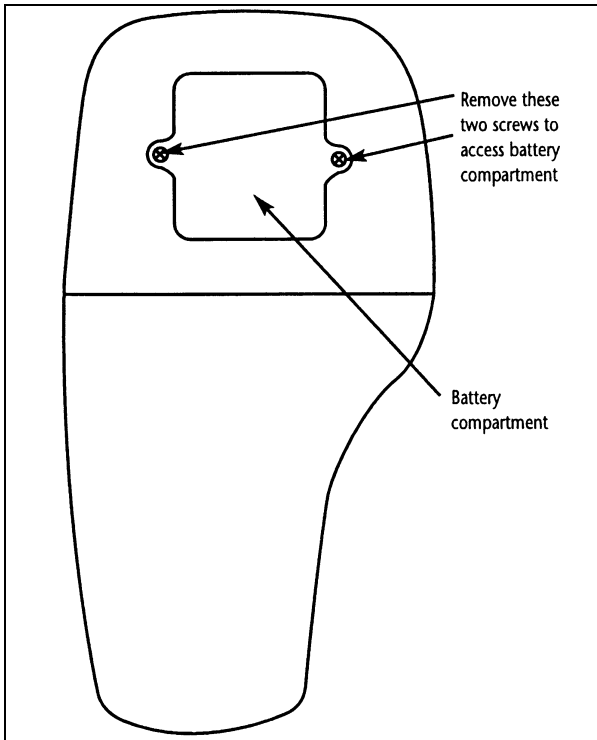

Figure 3 - Back Panel of Meter Showing Meter Compartment

3.2 Probe Information

Your meter includes two probes:

- pH electrode with BNC connector.
- conductivity/temperature probe with a notched 6-pin connector

The temperature sensing element built into the conductivity probe will also compensate for pH readings as long as both probes are in your solution at the same time.

If you want to use a “3-in-1” pH probe with a built-in temperature element, or if you want to use a separate temperature probe, you will need to disconnect the conductivity probe to allow for connection of the separate temperature sensor.

You can use any standard pH electrode with a BNC connector with this meter. Conductivity probes, “3-in-1” pH electrodes with a built-in temperature element, and temperature probes require a notched 6-pin connector (see Figure 4). For replacement probes, see the “Accessories” section on page 56.

NOTE: Keep connector dry and clean. Do not touch connector with soiled hands.

To connect the pH electrode :

- 1 Slide the BNC connector of the probe over the BNC connector socket on the meter. Make sure the slots of the connector are in line with the posts of the socket. Rotate and push the connector clockwise until it locks.
- 2 To remove electrode, push and rotate the connector anti-clockwise. While holding onto the metal part of the connector, pull it away from the meter.

CAUTION: Do not pull on the probe cord or the probe wires might disconnect.

To Connect the Conductivity/Temperature Probe :

- 1 Line up the notch and 6 pins on the probe connector with the holes in the connector located on the top of the meter. Push down and screw the metal sleeve to lock the probe connector into place. See Figure 4.
- 2 To remove probe, unscrew the metal sleeve and slide up the probe connector. While holding onto metal sleeve, pull probe away from the meter.

NOTE: Follow the same directions to connect an optional separate temperature element.

CAUTION: Do not pull on the probe cord or the probe wires might disconnect.

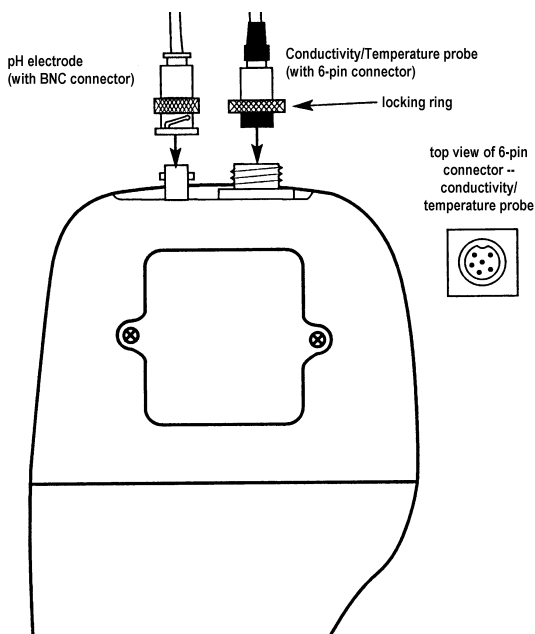

Figure 4: Connecting pH and Conductivity/Temperature Probes

4 CALIBRATION

4.1 Important Information on Meter Calibration

When you re-calibrate your meter, old calibration points are replaced on a “point-by-point” basis in pH, and on a “range-by-range” basis in conductivity.

For example:

- **pH** - if you previously calibrated your meter at pH 4.01, 7.00, and 10.01, and you re-calibrate at pH 7.00, the meter retains the old calibration data at pH 4.01 and pH 10.01.
- **Conductivity** - if you previously calibrated your conductivity meter at 1413 μS in the 0 to 1999 μS range and you re-calibrate at 1500 μS (which is also in the 0 to 1999 μS), the meter will replace the old calibration data (1413 μS) in that range. The meter will retain all calibration data in other ranges.
- **TDS** - if you previously calibrated your conductivity meter at 300 ppm in the 0 to 999 ppm range and you re-calibrate at 500 ppm (which is also in the 0 to 999 ppm), the meter will replace the old calibration data (300 ppm) in that range. The meter will retain all calibration data in other ranges.

To view current calibration points:

- **pH** - Program P1.0 in the SETUP section, page 34
- **Conductivity and TDS** - Program P5.0 in the SETUP section, Page 41

To completely re-calibrate your meter, or when you use a replacement probe, it is best to delete the old calibration data by re-setting the meter.

To reset the meter to its factory defaults:

- **pH** - Program P4.0 in the SETUP section, page 40
- **Conductivity and TDS** - Program P9.0 in the SETUP section, page 49

NOTE: Re-setting the meter will set meter to factory defaults. Conductivity and pH must be reset separately.

For directions on how to calibrate your meter:

- See section 4.3 on pages 8 – 10 for pH calibration
- See section 4.4 on pages 11 – 13 for conductivity calibration
- See section 4.4 on pages 14 – 15 for TDS calibration
- See section 4.5 on pages 16 – 17 for Temperature calibration.

4.2 Preparing the Meter for Calibration

Before starting calibration, make sure you are in the correct measurement mode. When you switch on the meter, the meter starts up in the measurement mode you shut it off in. For example, if you shut the meter off in pH measurement mode, the meter will come back into pH measurement mode when you switch the meter on.

4.3 pH Calibration

NOTE: *We recommend that you perform at least 2-point calibration using standard buffers that bracket (one above and one below) the expected sample range.*

Preparing for pH Calibration

This meter is capable of up to 5-point pH calibration to ensure accuracy across the entire pH range of the meter. Select from the following buffer options:

- pH 1.68, 4.01, 7.00, 10.01 and 12.45.

The meter automatically recognizes and calibrates to these standard buffer values, which makes pH calibration faster and easier.

Be sure to remove the protective electrode storage bottle or rubber cap of the electrode before calibration or measurement. If the electrode has been stored dry, wet the electrode in tap water for 10 minutes before calibrating or taking readings to saturate the pH electrode surface and minimize drift.

Wash your electrode in deionised water after use, and store in electrode storage solution. If storage solution is not available, use pH 4.01 or 7.00 buffer solution.

Do not reuse buffer solutions after calibration. Contaminants in the solution can affect the calibration and eventually the accuracy of the measurements. See page 56 for information on our high-quality Palintest pH buffer solutions.

To Calibrate pH :-

- 1 If necessary, press the **MODE** key to select pH mode. The pH indicator appears in the upper right hand corner of the display.
- 2 Rinse the probe thoroughly with deionised water or a rinse solution. Do not wipe the probe; this causes a build-up of electrostatic charge on the glass surface.
- 3 Dip the probe into the calibration buffer. The end of the probe must be completely immersed into the sample. Stir the probe gently to create a homogeneous sample.

NOTE: The temperature element is in the conductivity cell. For temperature compensated readings, dip the conductivity cell into the calibration buffer as well.

- 4 Press **CAL/MEAS** to enter pH calibration mode. The CAL indicator will be shown. The primary display will show the measured reading while the smaller secondary display will indicate the pH standard buffer solution.
- 5 Wait for the measured pH value to stabilize. See Figure 5.

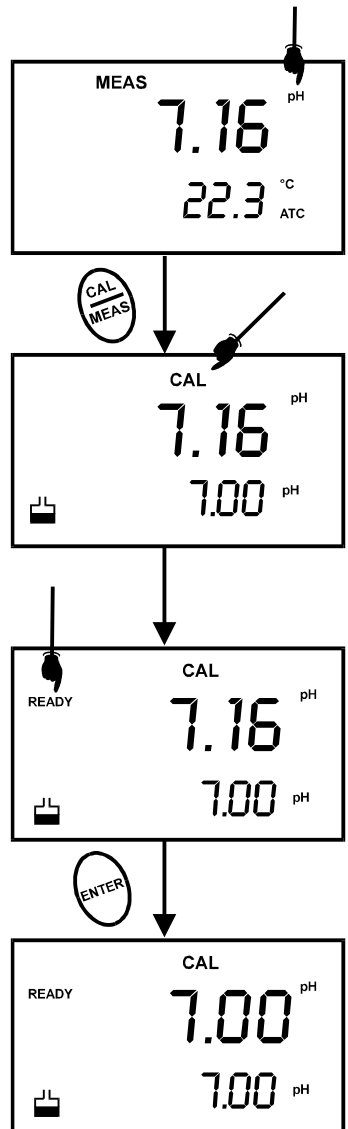

Figure 5 - pH Calibration

- 6 Press **ENTER** to confirm calibration. The meter is now calibrated to the current buffer. The lower display scrolls through the remaining buffer options.
 - If you are performing multi-point calibration, go to Step 7.
 - If you are performing one-point calibration, go to Step 9.
- 7 Rinse the electrode with deionised water or in rinse solution, and place it in the next pH buffer.
- 8 Follow Steps 5 to 8 for additional calibration points. See Figure 6.
- 9 When calibration is complete, press CAL/MEAS to return to pH measurement mode.

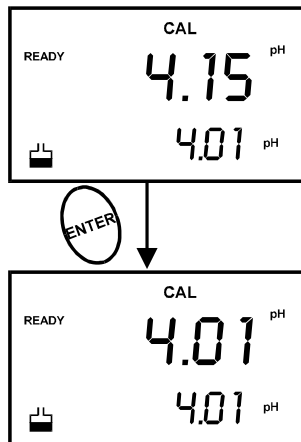

Figure 6 - Next Point Calibration for pH 4.01

NOTES: To exit from pH calibration mode without confirming calibration, DO NOT press ENTER in Step 6. Press CAL/MEAS instead.

If the selected buffer value is not within ± 1.0 pH from the measured pH value: the electrode and buffer icon blink and the ERR annunciator appears in the lower left corner of the display. Figure 7.

To limit the number of pH buffer values available during calibration, see SETUP section P3.2 on Page 38.

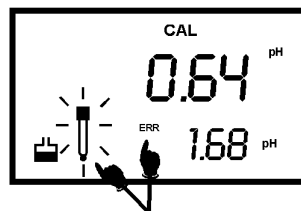

Figure 7 - Err Message and Electrode Icon will appear if Incorrect Buffer are Used

4.4 Conductivity Calibration

The PC 300 meter has five measuring ranges. You can calibrate one point in each of the measuring ranges (up to five points). If you are measuring values in more than one range, make sure to calibrate each of the ranges you are measuring. All new calibration data will over-ride existing stored calibration data for each measuring range you calibrate :

- If you are measuring in ranges near to or greater than 20 mS (10 ppt), or near to or lower than 100 μ S (50 ppm), calibrate the meter at least once a week to get specified $\pm 1\%$ F.S. accuracy.
- If you are measuring in the mid ranges and you washed the probe in deionised water and stored it dry, calibrate the meter at least once a month.
- If you take measurements at extreme temperatures, calibrate the meter at least once a week.

Preparing for Conductivity Calibration

For best results, select a standard value close to the sample value you are measuring. Alternatively use a calibration solution value that is approximately 2/3 the full-scale value of the measurement range you plan to use. For example, in the 0 to 1999 μ S conductivity range, use a 1412 μ S solution for calibration.

Table 1 - Range Indicator and its Corresponding Ranges

Range indicator	Conductivity Range	Recommended Calibration Solution Range	TDS Range	Recommended Calibration Solution Range
r 1	0.00 \rightarrow 19.99 μ S	6.00 to 17.00 μ S	0.00 \rightarrow 9.99 ppm	3.00 to 10 ppm
r 2	0.0 \rightarrow 199.9 μ S	60.0 to 170.0 μ S	10.0 \rightarrow 99.9 ppm	30.0 to 100 ppm *
r 3	0 \rightarrow 1999 μ S	600 to 1700 μ S	100 \rightarrow 999 ppm	300 to 1000 ppm *
r 4	0.00 \rightarrow 19.99 mS	6.00 to 17.00 mS	1.00 \rightarrow 9.99 ppt	3.00 to 10 ppt *
r 5	0.0 \rightarrow 199.9 mS	60.0 to 170.0 mS	10.0 \rightarrow 200 ppt	30.0 to 200 ppt

Temperature Coefficient: These meters are factory set to a temperature coefficient of 2.1% per $^{\circ}$ C. For most applications this will provide good results. See Program P8.1 on Page 47 to set the temperature coefficient to different value. See Addendum 3, "Calculating Temperature Coefficients" to determine the appropriate temperature coefficient for your solution.

Normalization Temperature: The factory default value for normalization temperature is 25 $^{\circ}$ C. If you need to normalize to a value other than 25 $^{\circ}$ C, see Program P8.2 on page 48.

*** Palintest Standard Conductivity/TDS Solutions are available to suit these ranges – see Page 56.**

Do not reuse calibration solutions after calibration. Contaminants in the solution can affect the calibration, and eventually the accuracy of the measurements. Use fresh calibration solution each time you calibrate your meter.

All new calibration data will over-ride existing stored calibration data for each measuring range calibrated.

Calibrating for Conductivity :-

- 1 If necessary, press the **MODE** key to select conductivity mode.
 - 2 Rinse the probe thoroughly with deionised water or a rinse solution, then rinse with a small amount of calibration standard.
 - 3 Dip the probe into the calibration standard. Immerse the probe tip beyond the upper steel band. Stir the probe gently to create a homogeneous sample. See Figure 8.
 - 4 Wait for the measured conductivity value to stabilize. If the READY indicator has been activated (SETUP program P7.1 – see page 43), the READY annunciator lights when the reading is stable.
 - 5 Press **CAL/MEAS** to enter conductivity or TDS calibration mode. The CAL indicator will appear in the upper right corner of the display.
 - 6 Press the ▲ or ▼ keys to change the value on the primary display to match the value of the calibration standard.
 - 7 Press **ENTER** to confirm calibration value. The meter returns to the MEAS (measurement) mode.
 - 8 Repeat steps 1 to 7 for other measuring ranges.
- See Figure 8.

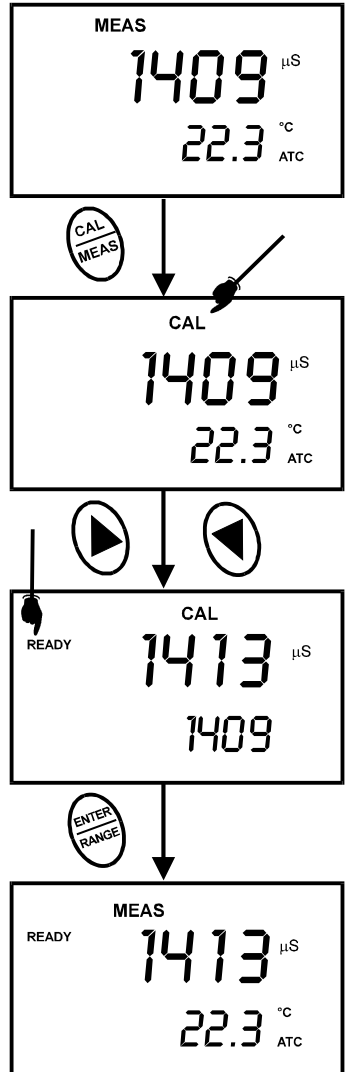

Figure 8 - Conductivity Calibration

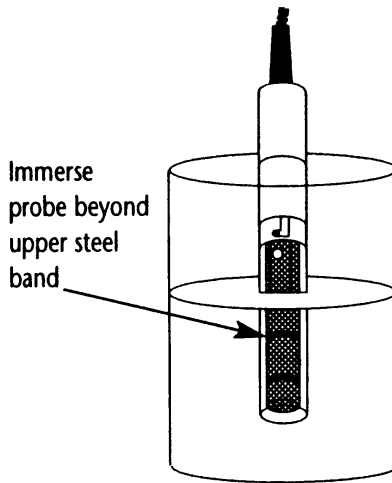

Figure 9 - Proper Immersion of the Conductivity Probe

NOTES:

When entering calibration mode, the meter will display the factory default value. If the meter was previously calibrated, the display may “jump” to the factory default value when switching from measurement to calibration mode.

To exit from Conductivity calibration mode without confirming calibration, DO NOT press the ENTER key in Step 6. Press CAL/MEAS instead. This will retain the meter’s old calibration data in the measuring range of the calibration.

You can offset the conductivity reading up to $\pm 40\%$ from default setting. If your measured value differs by more than $\pm 40\%$, clean or replace probe as needed.

Palintest offers a wide selection of high-quality calibration standards. See Page 56 for more information.

4.5 TDS Calibration

4.5.1 Calibrating for TDS Directly

The factory default setting for TDS conversion factor is 0.5. If your solution has a different TDS factor, you can improve calibration accuracy by setting the TDS factor prior to calibration. See P7.4 on Page 46 for directions.

- 1 If necessary, press the **MODE** key to select TDS mode.
- 2 Rinse the probe thoroughly with deionised water or a rinse solution, then rinse with a small amount of calibration standard.
- 3 Dip the probe into the calibration standard. Immerse the probe tip beyond the upper steel band. Stir the probe gently to create a homogeneous sample. Allow time for the reading to stabilize.
- 4 Press **CAL/MEAS** to enter TDS calibration mode. The CAL indicator will appear in the upper right corner of the display.
- 5 Press the **▲** or **▼** keys to change the value on the primary display to match the value of the calibration standard.
- 6 Press **ENTER** to confirm the calibration value. The meter returns to the MEAS (measurement) mode. See Figure 10.
- 7 Repeat steps 1 to 6 for other measuring ranges.

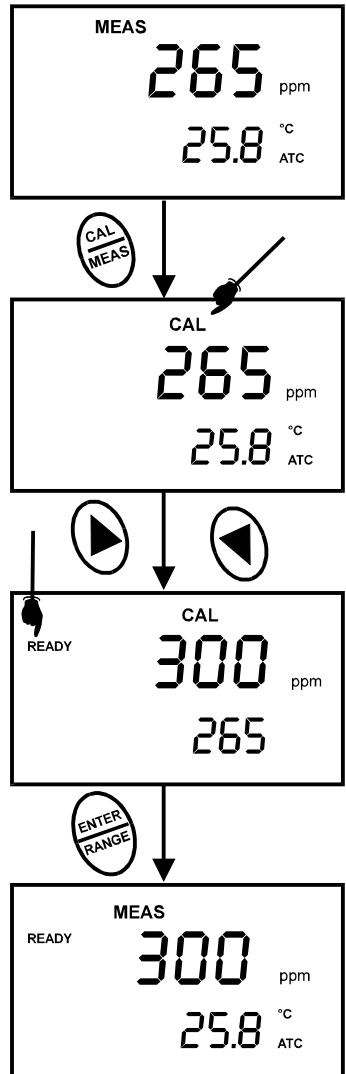

Figure 10 - TDS Calibration

NOTES

To exit from TDS Calibration mode without confirming calibration, DO NOT press the ENTER key in step 6. Press CAL/MEAS instead. This will retain the meter's old calibration data in the measuring range of the calibration. You can offset the TDS reading up to $\pm 20\%$ from the default setting. If your measured value differs by more than $\pm 40\%$, clean or replace probe as needed.

4.6 Calibration with Conductivity Standard and TDS factor

The concentration of salts dissolved in solution increases the conductivity of that solution. This relationship varies from salt to salt and is roughly linear over a given range for a given salt. The TDS conversion factor is the number used by the meter to convert from conductivity to TDS.

Instead of calibrating for TDS directly (described above), you can calibrate the PC 300 meter by :-

- 1 Calibrating to conductivity standards (as described above), and then
- 2 Entering the appropriate TDS conversion factor into the meter.

To Determine the Conductivity to TDS Conversion Factor for your Solution :-

- Addendum 1 on Page 57 lists some commonly used conversion factors.
- Addendum 2 on Page 58 describes how to calculate the TDS conversion factor for other solutions.

Enter the TDS conversion factor into your meter as described under Section 7.5, in *P7.4 Setting the TDS Factor* on Page 46.

4.7 Temperature Calibration

The conductivity electrode (EC-CONSEN91W) supplied with the meter has a built-in temperature sensor. In addition you can also use a separate temperature sensing element supplied by Palintest (as such temperature probe, EC-PHWPTEMP-01W, or the “3-in-1” pH/Temperature combination electrode, EC-FE73528-01W) for ATC purpose.

The conductivity probe is factory calibrated. Temperature calibration can be done only if you suspect temperature errors that may have occurred over a long period of time, or if you have a replacement probe.

Temperature calibration is accessible during pH or conductivity or TDS calibration.

Temperature Calibration

1. Make sure the conductivity electrode (or temperature probe or “3-in-1” electrode) is attached to the 6-pin connector.
2. Switch the meter on.
3. Press the **CAL/MEAS** key to enter calibration mode (either from pH or conductivity mode). The **CAL** indicator will appear above the primary display.
4. While in pH (or conductivity or TDS) calibration mode, press the **MODE** key to enter temperature calibration mode. The primary display shows the last set temperature value and the secondary display shows the temperature reading with zero offset.
5. Dip the ATC probe into a solution of known temperature (ie a temperature bath). Allow time for the temperature probe to stabilize.
6. Scroll with the **▲** and **▼** keys to set the correct temperature value (ie the temperature of the temperature bath). You can adjust the reading increments of 0.1 °C.
7. Once you have selected the correct temperature press the **ENTER** key. The meter automatically returns to pH measurement mode. See Figure 11.

NOTES :

- You can offset the temperature reading up to $\pm 5^{\circ}\text{C}$ from original reading.
- To exit this program without confirming the temperature calibration value, **DO NOT press ENTER** - press **CAL/MEAS** instead.

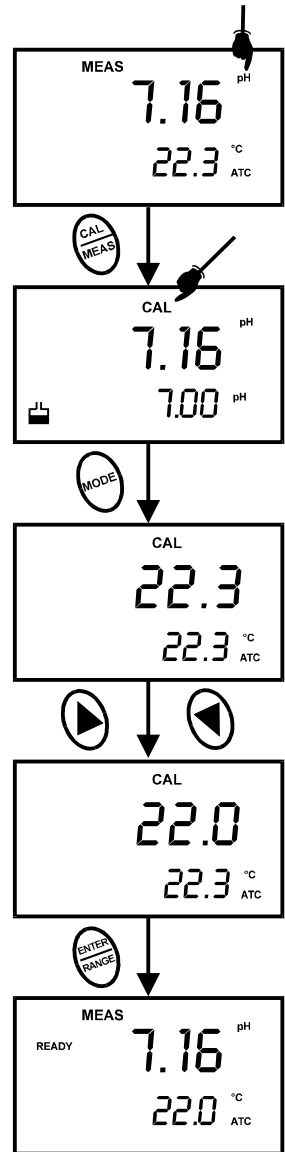

Figure 11 - Temperature Calibration in pH Mode

5 MEASUREMENT

5.1 Taking pH Measurements

5.1.1 Automatic Temperature Compensation

Automatic Temperature Compensation only occurs when a temperature sensing element is plugged into the meter.

Temperature sensing element refers to the following probes made specifically for this meter :

- *The conductivity electrode (EC-CONSEN91W) with a built-in temperature sensor;*
- *Temperature probe, EC-PHWPTMP-01W; or*
- *The “3-in-1” pH/Temperature combination electrode, EC-FE73528-01W.*

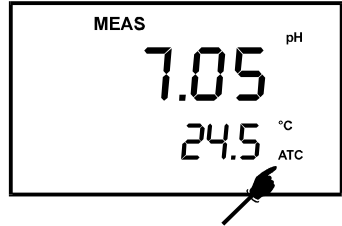

Figure 12 - ATC Annunciator will light up when Connected to Temperature Probe

If there is no temperature sensor plugged into the meter, the default manual temperature setting is automatically 25°C. You can manually set the temperature to match your working conditions using a separate thermometer.

For automatic temperature compensation (ATC) simply plug the temperature probe into the meter (see page 6 for directions). The ATC indicator will light up on the LCD. See Figure 12.

NOTE: The temperature sensing element must be submersed in the liquid you are measuring.

5.1.2 Manual Temperature Compensation (pH)

IMPORTANT: For manual compensation, you must disconnect the temperature probe (see page 6).

- 1 Switch the meter on. Press the **MODE** key to select pH mode.
- 2 Press the **CAL/MEAS** key to enter pH calibration mode. The CAL indicator will appear above the primary display.
- 3 While in pH calibration mode, press the **MODE** key to enter temperature calibration mode. The primary display shows the current temperature setting and the secondary display shows the default value 25 °C.
- 4 Check the temperature of your sample using an accurate thermometer.
- 5 Press the ▲ or ▼ keys to set the temperature to the measured value from step 4.
- 6 Press **ENTER** to confirm the selected temperature and to return to the pH measurement mode.

See Figure 13.

The meter will now compensate pH readings for the manually set temperature.

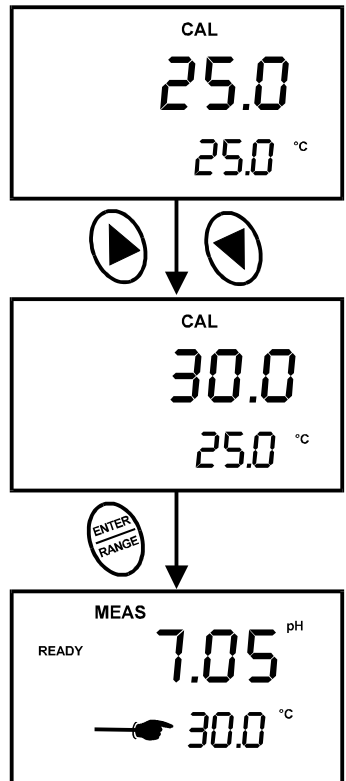

Figure 13 - Manual Temperature Compensation

NOTES :

To exit this program without confirming the manual temperature compensation value, **DO NOT press ENTER** in Step 6 - press **CAL/MEAS** instead.

5.1.3 Taking Measurements (pH)

Be sure to remove the electrode soaker bottle or protective rubber cap on the electrode before measurement.

To Take Readings :-

- 1 Rinse the pH electrode with deionised or distilled water before use to remove any impurities adhering to the probe body. If the pH electrode has dehydrated, soak it for 30 minutes in Palintest electrode storage solution or 2M – 4M KCl solution (sold separately).
- 2 Press **ON** to switch on meter.
- 3 Press the MODE key to select pH measurement mode. The MEAS annunciator appears on the top center of the LCD. The ATC indicator appears in the lower right-hand corner to indicator Automatic Temperature Compensation.

NOTE: For pH manual temperature compensation, you must disconnect the conductivity cell from the 6-pin connector. The ATC indicator will disappear from the display. You also need to set a manual temperature compensation value. See page 19 (Figure 13) to set Manual Temperature Compensation.

- 4 Dip the probe into the sample. Since the conductivity cell contains the temperature sensor, make sure it is also immersed in your solution.

When dipping the probe into the sample, the sensor or the glass bulb of the electrode must be completely immersed into the sample. Stir the probe gently in the sample to create a homogeneous sample.

- 5 Allow time for the reading to stabilise. Note the reading on the display. Note the reading on the display. If the Ready indicator is selected on, it will appear when the reading is stable. See below for more information.

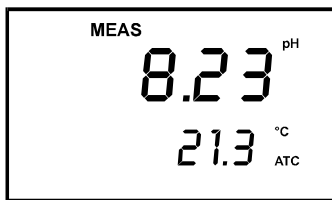

Figure 14 - Measurement Mode

Taking Measurements with READY Indicator Selected On

If the READY indicator has been activated, the READY annunciator lights when the reading is stable*. *Switch the READY indicator on or off in SETUP program P3.1. See Page 37 for directions.*

* *The READY indicator appears and the reading holds until the measured value exceeds the tolerance (± 0.02 pH; ± 0.8 mV <400; ± 1.2 mV > 400). Then, the READY annunciator turns off.*

Taking Measurements with the Auto-Endpoint Feature Selected On

When a reading is stable for more than 5 seconds, the auto endpoint feature will automatically "HOLD" the reading. The "HOLD" indicator appears on the left side of the display. Press the HOLD key to release the reading. Switch the Auto endpoint feature on or off in SETUP program P 3.1, see Page 37 for instructions.

5.2 Taking Conductivity or TDS Measurement

5.2.1 Automatic Temperature Compensation

For automatic temperature compensation (ATC) simply plug the conductivity probe into the meter (see page 6 for directions). The ATC indicator will light on the LCD.

NOTE: If the ATC indicator does not light, manual temperature compensation may be selected in the meter's SETUP mode. See Program P7.3 on page 45 for directions on selecting Automatic Temperature Compensation.

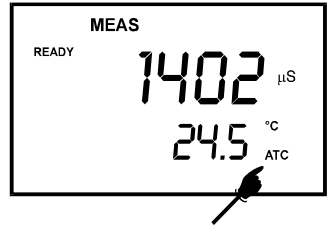

Figure 15 - ATC Annunciator will light up when Connected to Temperature Probe

5.2.2 Manual Temperature Compensation

IMPORTANT: For manual compensation, you must deactivate the temperature probe.

Selecting Manual Temperature Compensation for Conductivity

Selecting between Automatic Temperature Compensation (ATC) and Manual Temperature Compensation in the SETUP program P7.3 on Page 45. Meter default is ATC on.

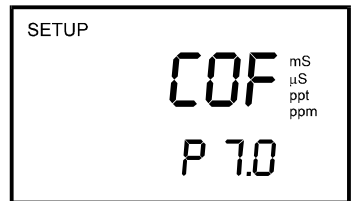

Figure 16 - P7.0 Configuration Set-Up for Conductivity and TDS

From Conductivity or TDS Measurement Mode

- 1) Press **SETUP** key to enter Set Up mode.
- 2) Press the **▲** or **▼** keys to scroll through subgroups until you view parameter P7.0. See Figure 16.
- 3) Press the **ENTER** key three times to select parameter 7.3. The upper display shows "ATC" and the lower display shows "P7.3".
- 4) Press the **ENTER** key again. The upper display shows "ATC" and the lower display shows "YES" or "NO".

- 5) Press the ▲ or ▼ keys to select the Automatic Temperature Compensation feature on (ATC on) or off (ATC off). See Figure 18.
- 6) Press the **ENTER** key to confirm selection and to return to the subgroup menu. Press the **CAL/MEAS** key to return to measurement mode.

Note that the ATC indicator no longer appears on the display.

Proceed to next section to select a manual temperature compensation value.

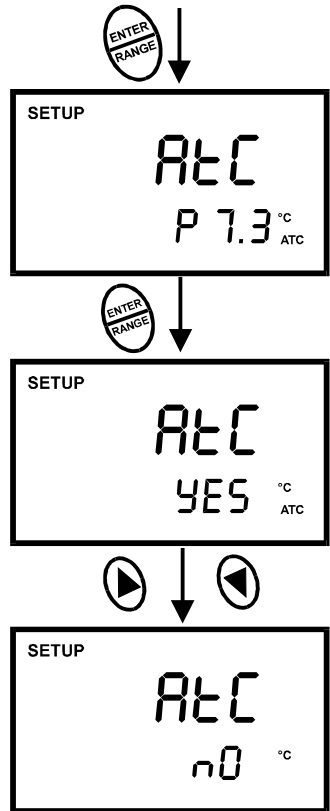

Figure 18 - Turning ATC Feature ON or OFF

5.2.3 Setting a Manual Temperature Compensation Value

To use manual temperature compensation, you need to enter the temperature value of your process into the meter. This is the value at which reading will manually temperature compensates. You can select any temperature between 0 and 100°C (32 to 212°F). Default value is 25°C (77°F).

To select a manual temperature compensation value

1. Switch the meter on. Press the **MODE** key to select conductivity or TDS measurement mode.
2. If necessary, select ATC off as described in section 5.2.2 on Page 22. The ATC indicator will not appear on the display.
3. Press the **CAL/MEAS** key to enter conductivity or TDS calibration mode. The CAL indicator will appear above the primary display.
4. While in conductivity (or TDS) calibration mode, press the **MODE** key to enter temperature calibration mode. The primary display shows the current temperature setting and the secondary display shows the default value 25°C (77°F) or its last set value.
5. Check the temperature of your sample using an accurate thermometer.
6. Press the **▲** or **▼** keys to offset the temperature to the measured value from step 5.
7. Press **ENTER** to confirm the selected temperature and to return to the conductivity measurement mode. See Figure 19.

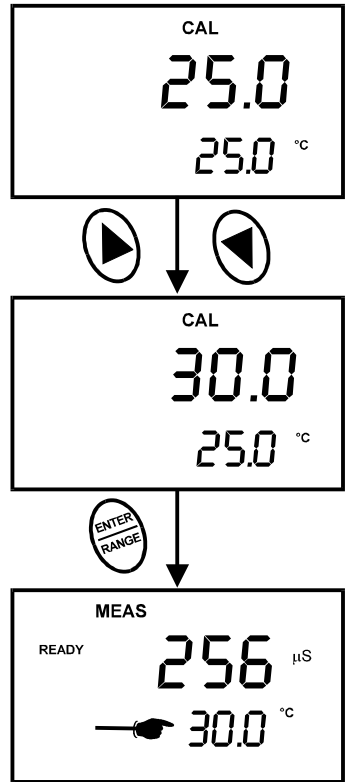

Figure 19 - Manual Temperature Compensation

The meter will now compensate conductivity or TDS readings for manually set temperature.

NOTES :

To exit this program without confirming the manual temperature compensation value, **DO NOT press ENTER** in Step 6 - press **CAL/MEAS** instead.

Setting the manual temperature compensation value for conductivity will change the manual temperature compensation value for pH to the same value, and vice versa.

5.2.4 Taking Measurements (Conductivity or TDS)

To Take Readings :

- 1 Rinse the probe with deionised or distilled water before use to remove any impurities adhering to the probe body. Shake or air dry. To avoid contamination or dilution of your sample, rinse probe with a small volume of your sample liquid.
- 2 Press **ON** to switch on meter.
- 3 Press the **MODE** key to select conductivity or TDS measurement mode. The MEAS annunciator appears on the top center of the LCD. The ATC indicator appears in the lower right hand corner to indicate Automatic Temperature Compensation.

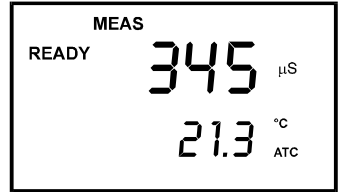

Figure 20 - During

NOTE: For conductivity manual temperature compensation, you must de-activate the temperature sensor built into the conductivity probe and set a manual temperature compensation. See Pages 22 – 23 for more information. The ATC indicator will disappear from the display.

- 4 Dip the probe into the sample -

When dipping the probe into the sample, take care to ensure that the liquid level is above its upper steel band. Stir the probe gently in the sample to create a homogenous sample. See Figure 9 on Page 13.

- 5 Allow time for the reading to stabilize. Note the reading on the display. If the READY indicator is selected on, it will appear when the reading is stable. See P71 on page 43 for more information.
- 6 Press the **MODE** key to toggle between conductivity, TDS and pH readings.

NOTES: You can use the conductivity manual ranging function to select a specific range in which your readings will appear. See Page 27 for directions.

Taking Measurements with READY Indicator Selected On

If the READY indicator has been activated, the READY annunciator lights when the reading is stable*. *Switch the READY indicator on or off in SETUP program P 7.1. See Page 43 for directions.*

Taking Measurements with the Auto-End-Point Feature Selected On

When a reading is stable for more than 5 seconds, the auto endpoint feature will automatically “HOLD” the reading. The “HOLD” indicator appears on the left side of the display. Press the HOLD key to release the reading. Switch the Auto endpoint feature on or off in SETUP program P 7.1, see Page 43 for instructions.

5.2.5 Using Auto and Manual Ranging Function (for Conductivity and TDS)

Auto-Ranging

Your meter automatically selects the range in which your readings appear. For example:

- 1 If you dip the conductivity probe into a standard solution, say, 12.88 mS.
- 2 It will automatically select the most appropriate range, **r 4**, which is 0.00 to 19.99 mS (refer to Table 1 on Page 11).
- 3 The secondary display on the LCD will momentarily display **r 4** before it switches to measured temperature value.
- 4 The primary display will show the actual conductivity value. See Figure 21.

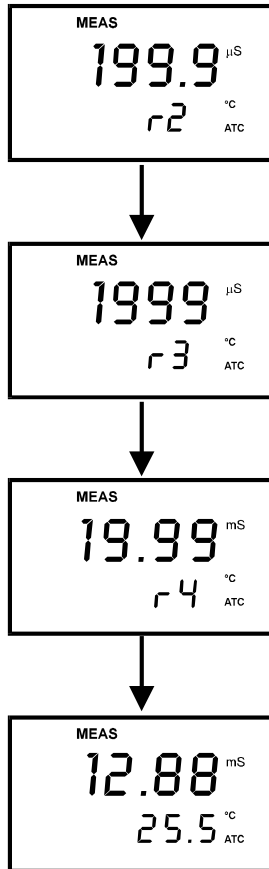

Figure 21 - Auto-Ranging Feature

Manual-Ranging

The manual ranging function lets you select the specific range you want to work in. Refer to page 11 for the table of range.

- 1 To select the desired measuring range, press the **RANGE** key while in Measurement mode. The first range will appear on the display and the “MEAS” indicator blinks. See Figure 22.
- 2 Press the **RANGE** key again (if needed) until desired range is selected.
- 3 To re-select the Auto-ranging function, repeatedly press the **RANGE** key until the “MEAS” indicator appears without blinking.

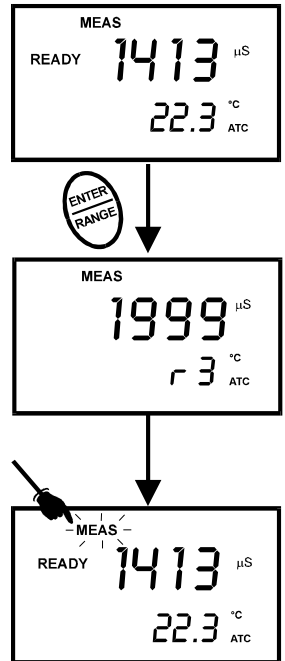

Figure 22 - Manual Ranging

NOTES

If the value of the solution you are measuring is higher than the range selected “Or” will appear on the primary display. Press RANGE until the correct range is selected.

The meter resets to the Auto-ranging function once it is turned off. You will have reset the manual ranging function each time you turn the meter off.

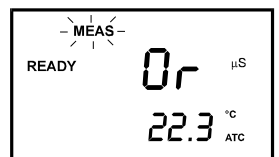

Figure 23 - Out-of-Range

6 HOLD FUNCTION

This feature lets you freeze the display for a delayed observation. HOLD can be used any time in MEAS mode.

1. To hold a measurement, press the **HOLD** key while in measurement mode. "HOLD" will appear on the display.
2. To release the held value, press the **HOLD** again. Continue to take measurements.

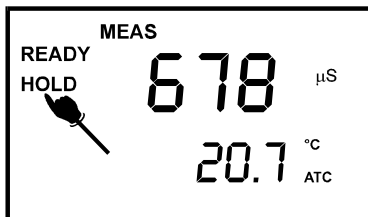

Figure 24 - HOLD Function

NOTE:

- This meter shuts off automatically after 20 minutes of last key press.
- If the meter is shut off either automatically or manually, the HOLD value will be lost.
- Your meter has an auto endpoint feature. When this feature is switched on, and when a reading is stable for more than 5 seconds, the display will automatically "HOLD" the reading. The "HOLD" indicator appears. Press the **HOLD** key to release the reading. To switch on or off the auto endpoint feature, see SETUP program P3.1 on Page 37 for pH and SETUP program P7.1 on Page 43 for conductivity/TDS.

7 ADVANCED SETUP FUNCTIONS

The advanced setup mode lets you customized your meter's preferences and defaults. The Palintest' Waterproof 800 meter features different sub-groups that organize setup parameters.

The sub-groups are:

For pH	
P 1.0	View calibration data (CAL)
P 2.0	View electrode data (ELE)
P 3.0	Unit Configuration (COF)
P 4.0	Reset to factory default settings (rSt)

For Conductivity and TDS	
P 5.0	View calibration data (CAL)
P 6.0	View electrode data (ELE)
P 7.0	Unit Configuration (COF)
P 8.0	Temperature (tPr)
P 9.0	Reset to factory default settings (rSt)

See Figure 25 on next page.

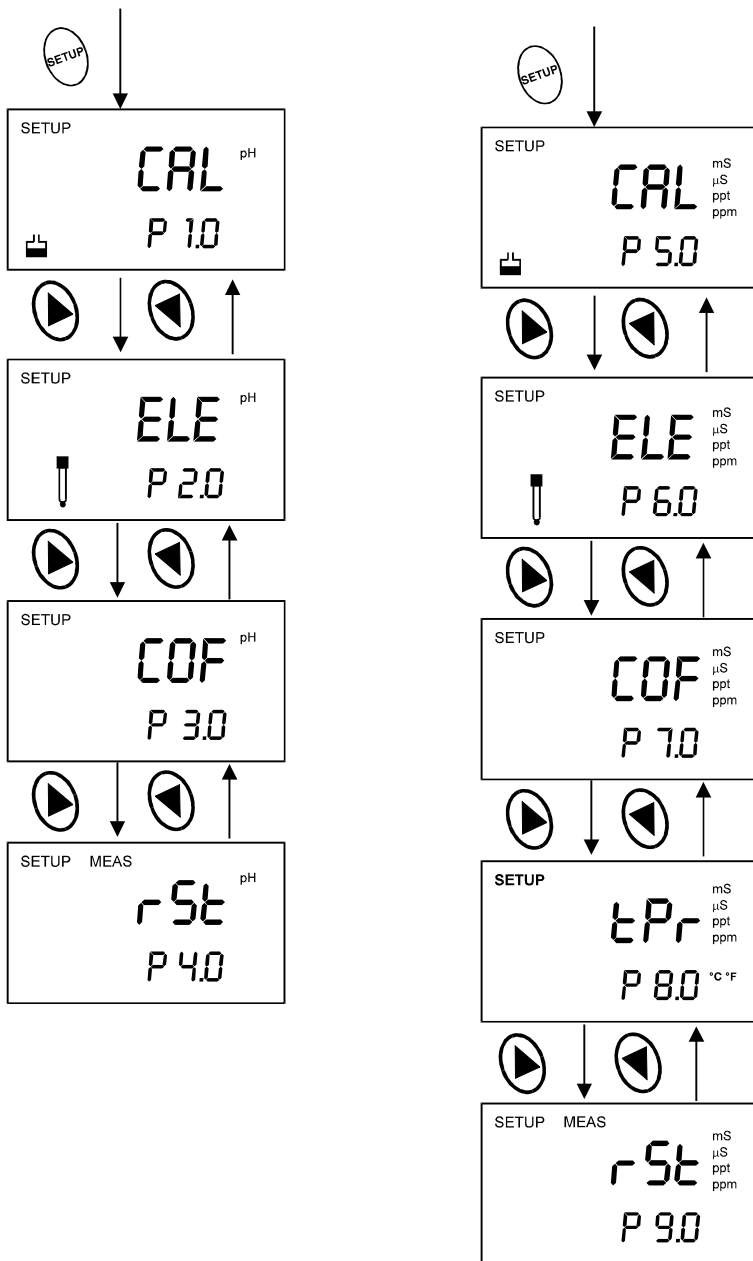

Figure 25 - Overall View of SETUP Programs for pH (on Left) and Conductivity/TDS (on Right)

7.1 Advanced SETUP Mode Overview

- 1 In either pH or Conductivity measurement mode, press the **SETUP** key to enter Set-Up mode.
- 2 Press the **▲** and **▼** keys to scroll through sub groups.
- 3 Press **ENTER** key to enter a particular parameter.

See Addendum 4 on Page 61 for a table of meter factory default settings.

SET-UP in pH Measurement Mode

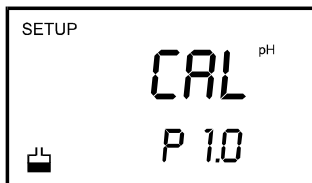

P1.0: View Previous Calibration Data

- P1.1 First calibration point (pH 1.68)
- P1.2 Second calibration point (pH 4.01)
- P1.3 Third calibration point (pH 7.00)
- P1.4 Fourth calibration point (pH 10.01)
- P1.5 Fifth calibration point (pH 12.45)

Instructions on Page 34

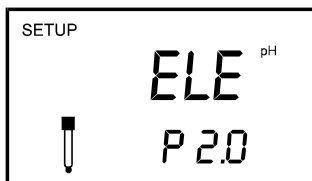

P2.0: View Electrode Data

- P2.1 pH electrode offset
- P2.2 pH electrode slope

Instructions on Page 35

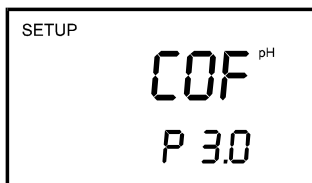

P3.0: Unit Configuration

- P3.1 READY indicator and auto endpoint function – select on or off
- P3.2 Number of pH calibration points: 2, 3, 4 or 5
- P3.3 Select °C or °F

Instructions on Page 36

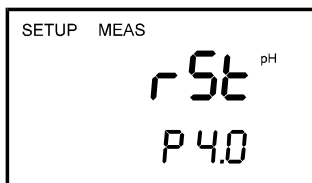

P4.0: Reset to Factory Defaults

- P4.0 Reset meter to factory defaults

Instructions on Page 40

SETUP in Conductivity Measurement Mode

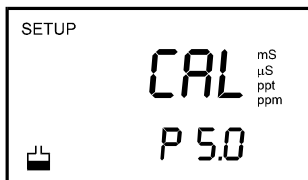

P5.0: View Previous Calibration Data

- P5.1 First range calibration point (0.00 – 19.99 µS)
- P5.2 Second range calibration point (0.0 – 199.9 µS)
- P5.3 Third range calibration point (0 – 1999 µS)
- P5.4 Fourth range calibration point (0.00 – 19.99 mS)
- P5.5 Fifth range calibration point (0.0 – 199.9 mS)

Instructions on Page 41

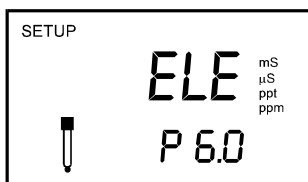

P6.0: View Electrode Data

- P6.1 Effective cell constant for first range (0.00 – 19.99 µS)
- P6.2 Effective cell constant for second range (0.0 – 199.9 µS)
- P6.3 Effective cell constant for third range (0 – 1999 µS)
- P6.4 Effective cell constant for fourth range (0.00 – 19.99 mS)
- P6.5 Effective cell constant for fifth range (0.0 – 199.9 mS)

Instructions on Page 42

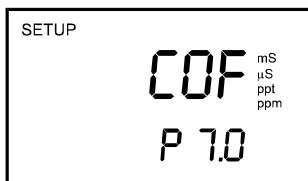

P7.0: Unit Configuration

- P7.1 READY indicator and auto endpoint function – select on or off
- P7.2 Select °C or °F
- P7.3 Select Automatic or Manual Temperature Compensation
- P7.4 Setting TDS conversion factor

Instructions on Page 43

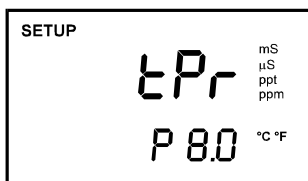

P8.0: Temperature

- P8.1 Adjusting temperature coefficient
- P8.2 Adjusting normalization temperature

Instructions on Page 47

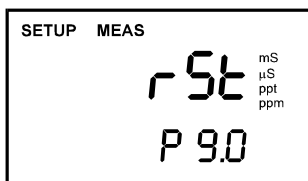

P9.0: Reset to Factory Defaults

- P9.0 Reset meter to factory defaults

Instructions on Page 49

SETUP in TDS Measurement Mode

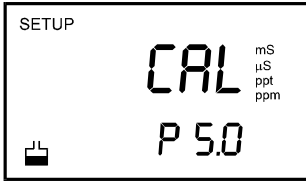

P5.0: View Previous Calibration Data

- P5.1 First range calibration point (0.00 – 9.99 ppm)
- P5.2 Second range calibration point (0.0 – 99.9 ppm)
- P5.3 Third range calibration point (0 – 999 ppm)
- P5.4 Fourth range calibration point (0.00 – 9.99 ppt)
- P5.5 Fifth range calibration point (0.0 – 200 ppt)

Instructions on Page 41

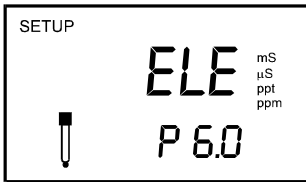

P6.0: View Electrode Data

- P6.1 Effective cell constant for first range (0.00 – 9.99 ppm)
- P6.2 Effective cell constant for second range (0.0 – 99.9 ppm)
- P6.3 Effective cell constant for third range (0 – 999 ppm)
- P6.4 Effective cell constant for fourth range (0.00 – 9.99 ppt)
- P6.5 Effective cell constant for fifth range (0.0 – 200 ppt)

Instructions on Page 42

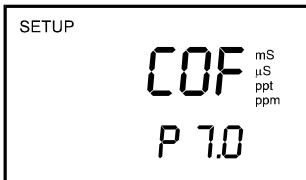

P7.0: Unit Configuration

- P7.1 READY indicator and auto endpoint function – select on or off
- P7.2 Select °C or °F
- P7.3 Select Automatic or Manual Temperature Compensation
- P7.4 Setting TDS conversion factor

Instructions on Page 43

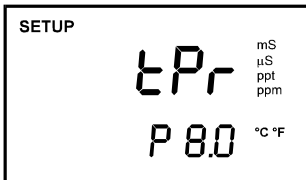

P8.0: Temperature

- P8.1 Adjusting temperature coefficient
- P8.2 Adjusting normalization temperature

Instructions on Page 47

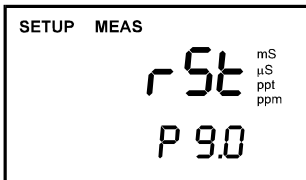

P9.0: Reset to Factory Defaults

- P9.0 Reset meter to factory defaults

Instructions on Page 49

7.2 P1.0: Viewing Previous pH Calibration Data

This mode lets you recall previous pH calibration data, which helps you know when to re-calibrate your meter. This is a “view only” mode.

From Measurement Mode:

- 1 Press the **MODE** key to select pH measurement mode if necessary.
- 2 Press the **SETUP** key to enter Set up mode.
- 3 Press the **▲** or **▼** keys to scroll through subgroups until you view parameter P1.0.
- 4 Press the **ENTER** key repeatedly to view previous calibration data. See Figure 26.
 - P1.1 = pH 1.68
 - P1.2 = pH 4.01
 - P1.3 = pH 7.00
 - P1.4 = pH 10.01
 - P1.5 = pH 12.45
- 5 When you have scrolled through all calibration data, you will automatically return to the subgroup menu. Press **CAL/MEAS** key to return to measurement mode.

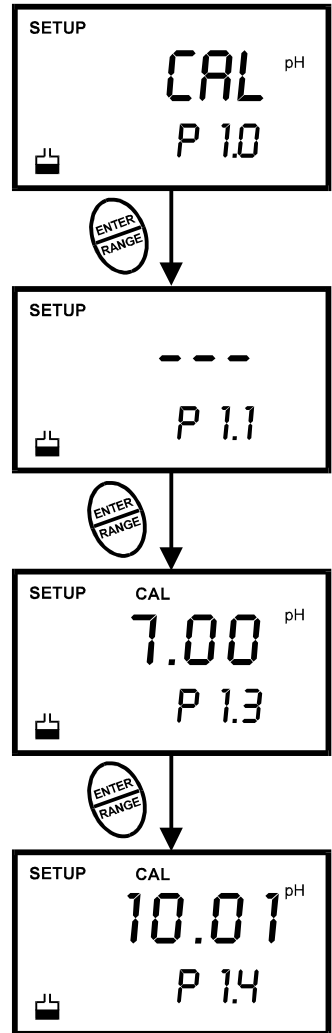

Figure 26 – P1.0: View Calibration Data for pH

NOTES :

If there is no previous calibration data at a particular point, the primary display will show “----”.

7.3 P2.0: Viewing pH electrode data

Program 2 has two “view only” options that let you check the electrode parameters for diagnostic purposes. It lets you view:

- P2.1 = Electrode offset
- P2.2 = Electrode slope

From pH measurement mode

1. Press the **MODE** key to select pH measurement mode.
2. Press the **SETUP** key to enter Set Up mode.
3. Press the **▲** or **▼** keys to scroll through subgroups until you view parameter P2.0.
4. Press the **ENTER** key to select parameter 2.1.
5. The display shows the electrode offset value. It is the mV offset at pH 7.00. If you have not calibrated at any buffer, the primary display shows 0.00 mV.
6. Press the **ENTER** key to proceed to P2.2.
7. The display shows electrode slope in percentage. Slope displayed is the average slope based on the pH calibrations. Default setting is 100.0.
8. At any point, you can press the **CAL/MEAS** key to return to measurement mode.

See Figure 27.

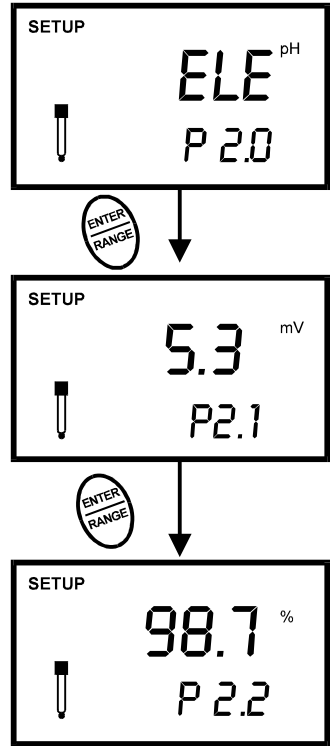

Figure 27 - Viewing Electrode's Offset and Slope Status from pH Measurement Mode

(The values shown above are for illustration purpose. Your meter may display different values depending on the settings & your environmental conditions)

7.4 P3.0: pH Measurement Configuration

This subgroup program allows to customize the meter to your specific needs. You can program the meter to :-

- 1 Select READY indicator ON or OFF
- 2 Select the number of pH calibration points
- 3 Select between °C and °F units for temperature readings

Figure 28 on the right shows the setup sequence for this program subgroup.

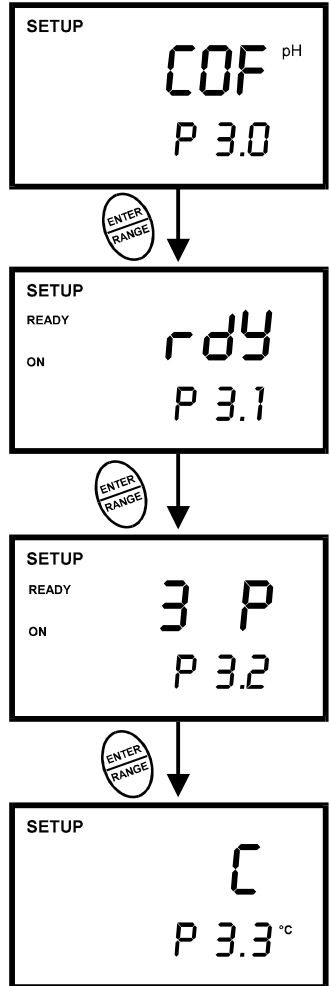

Figure 28 – P 3.0: Unit Configuration Program

P3.1: READY Indicator and Auto-Endpoint unction

This program lets you select :-

- “**READY Indicator On**” to indicate when the reading is stable.
- “**READY Indicator Off**” for faster meter response.
- **Auto-Endpoint Function On**. Select auto endpoint on to “hold” the reading when it is stable for more than 5 seconds. The display automatically freezes, and the HOLD indicator appears on the left side of the display. Press the HOLD key to release the display and access other functions.

From Measurement Mode :-

- 1 Press the **MODE** key to select pH measurement mode.
- 2 Press **SETUP** key to enter Set Up mode.
- 3 Press the **▲** or **▼** keys to scroll through subgroups until you view parameter P3.0.
- 4 Press the **ENTER** key to select parameter 3.1.
- 5 Press the **▲** or **▼** keys to select the configuration you require.
 - OFF switches the **READY** indicator off.
 - ON switches the **READY** indicator on.
 - ON and **HOLD** together switches the auto endpoint feature on.
- 6 Press the **ENTER** key to confirm selection and to proceed to step 4 of P3.2. Press the **CAL/MEAS** key to return to measurement mode.

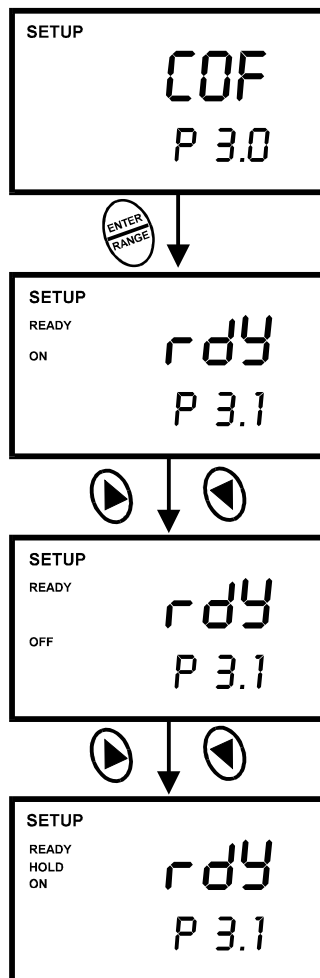

Figure 29 – P 3.1: Selecting READY Function)

NOTES:

Meter default is set for **READY** indicator on and auto-endpoint function off.

You can also change the Ready indicator and auto-endpoint function in Program P7.1 (available from conductivity or TDS mode). Any changes you make to the Ready indicator/auto endpoint function in pH mode will also change in conductivity mode.

P3.2: Selecting Number of pH Calibration Points

Program P3.2 lets you select the number of calibration points that appear in pH calibration mode: 2, 3, 4, or 5. The meter will automatically exit calibration mode after you have calibrated to your selected number of points.

From Measurement Mode :-

- 1 Press the **MODE** key to select pH measurement mode.
- 2 Press SETUP key to enter Set Up mode.
- 3 Press the ▲ or ▼ keys to scroll through subgroups until you view parameter P3.0.
- 4 Press the ENTER key twice to select parameter 3.2.
- 5 Press the ▲ or ▼ keys to select 2, 3, 4, or 5 point pH calibration.
- 6 Press the ENTER key to confirm selection and to return to the subgroup menu. Press CAL/MEAS key to return to measurement mode.

See Figure 30.

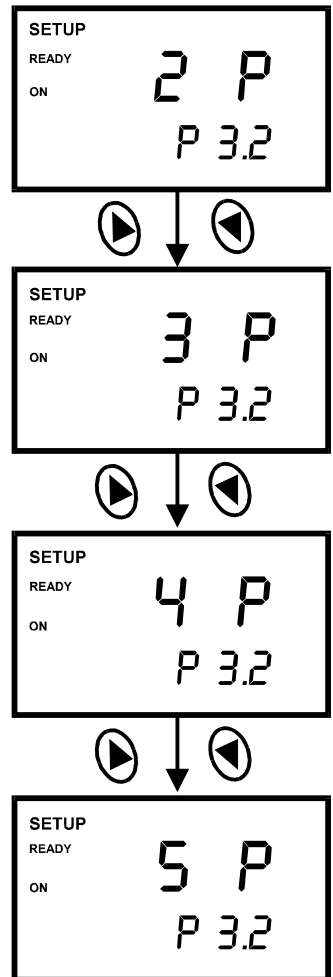

Figure 30 – P3.2: Select Number of pH Calibration Points

P3.3 Selecting °C or °F

This meter lets you select between °C and °F units for temperature readings.

From Measurement Mode :-

1. Press the **MODE** key to select pH measurement mode.
2. Press SETUP key to enter Set-Up mode.
3. Press the ▲ or ▼ keys to scroll through subgroups until you view parameter P4.0.
4. Press the ENTER key four times to select parameter 3.3.
5. Press the ▲ or ▼ keys to toggle between °C and °F.
6. Press the ENTER key to confirm selection and to return to the subgroup menu. Press the CAL/MEAS key to return to measurement mode.

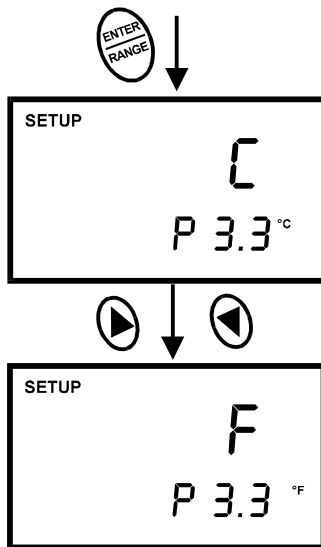

Figure 31 – P3.3: Select Temperature Units

See Figure 31.

NOTES :

- You can switch between °C and °F in Program P7.2 (available from conductivity or TDS mode). If you switch between °C and °F in pH mode, the meter will also switch in conductivity or TDS mode.

7.5 P4.0: Resetting to Factory Default Settings (pH)

This program lets you reset all pH parameters to factory default settings. This clears all calibration data and any other pH setup functions you might have changed.

The following settings will remain as you have set them:

- Temperature unit of measure (°C or °F)
- The temperature offset calibration value
- All conductivity calibration data and parameters.

From Measurement Mode :-

- 1 Press the **MODE** key to select pH measurement mode.
- 2 Press SETUP key to enter Set Up mode.
- 3 Press the ▲ or ▼ keys to scroll through subgroups until you view parameter P4.0.
- 4 Press the ENTER key to enter parameter P4.0. See Figure 32.
- 5 Press the ▲ or ▼ keys to toggle between NO and YES.
 - NO retains current settings
 - YES resets to factory default settings.
- 6 Press the ENTER key to confirm selection and to return to the measurement mode. Otherwise press CAL/MEAS key to return to measurement mode without resetting to factory default.

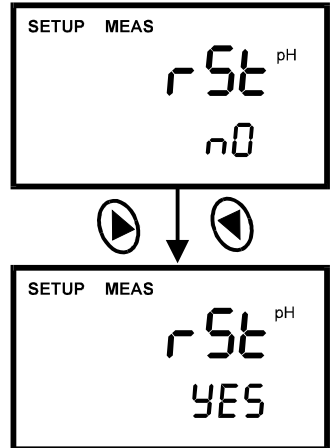

Figure 32 – P4.0: Reset to Factory Default Values (pH 300 Meter Only)

Notes :

- To clear all conductivity & TDS data, see Page 49.
- See Addendum 4 on Page 61 for a table of factory default settings.

7.6 P5.0: Viewing Previous Conductivity Calibration Data

This mode lets you recall previous calibration data, which helps you know when to re-calibrate your meter. This is a “view only” mode.

This function applies for conductivity & TDS mode.

From conductivity or TDS Measurement Mode :-

- 1 Press the **MODE** key to select conductivity or TDS measurement mode.
- 2 Press the **SETUP** key to enter Set up mode.
- 3 Press the **▲** or **▼** keys to scroll through subgroups until you view parameter P5.0.
- 4 Press **ENTER** key repeatedly to view previous calibration data.
- 5 Each calibration data corresponds to each measurement range.
 - P5.1 = Range 1 (0.00 – 19.99 μ S or 0.00 – 9.99 ppm)
 - P5.2 = Range 2 (0.0 – 199.9 μ S or 0.0 – 99.9 ppm)
 - P5.3 = Range 3 (0 – 1999 μ S or 0 – 999 ppm)
 - P5.4 = Range 4 (0.00 – 19.99 mS or 0.00 – 9.99 ppt)
 - P5.5 = Range 5 (0.0 – 199.9 mS or 0.0 – 99.9 ppt)
- 6 When you have scrolled through all calibration data, you will automatically return to the subgroup menu. Press **CAL/MEAS** key to return to measurement mode.

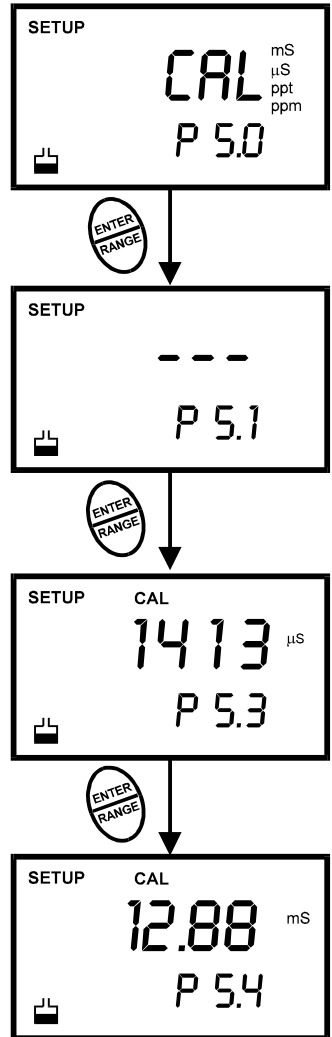

Figure 33 - View Calibration Data in Conductivity Probe

NOTES :

If there is no previous calibration data at a particular point, the primary display will show “----”.

7.7 P6.0: Viewing Conductivity Probe Data

Program 6 has five “view only” options that let you check the probe’s parameters for diagnostic purposes. These options show you the effective cell constant for each range. The cell constant is adjusted according to your calibration.

This function applies for conductivity & TDS mode.

From Conductivity or TDS Measurement Mode :-

- 1 Press the **MODE** key to select conductivity or TDS measurement mode.
- 2 Press the **SETUP** key to enter Set Up mode.
- 3 Press the **▲** or **▼** keys to scroll through subgroups until you view parameter P6.0.
- 4 Press the **ENTER** key repeatedly to view the effective cell constant for each range.
 - P6.1 = Range 1 (0.00 – 19.99 μ S or 0.00 – 9.99 ppm)
 - P6.2 = Range 2 (0.0 – 199.9 μ S or 0.0 – 99.9 ppm)
 - P6.3 = Range 3 (0 – 1999 μ S or 0 – 999 ppm)
 - P6.4 = Range 4 (0.00 – 19.99 mS or 0.00 – 9.99 ppt)
 - P6.5 = Range 5 (0.0 – 199.9 mS or 0.0 – 99.9 ppt)
- 5 When you have scrolled through all probe data, you will automatically return to the subgroup menu. Press the **CAL/MEAS** key to return to measurement mode. See Figure 34.

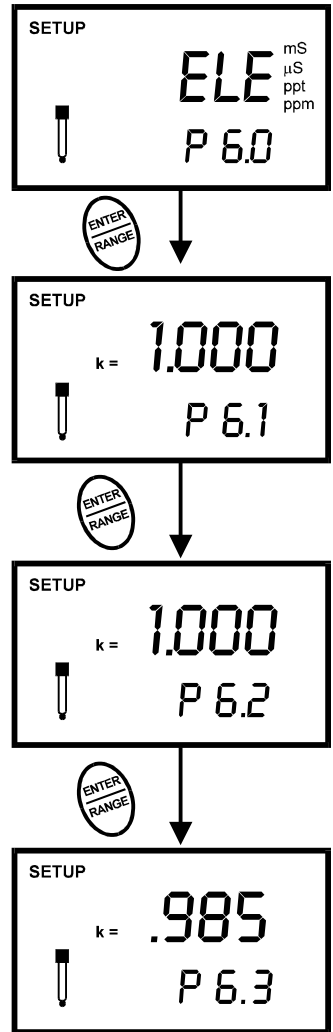

Figure 34 - View Probe Data for Each Measurement Range

NOTES :

Cell constants will degrade with time and usage. You can use this feature to alert you to the need for a new probe prior to total failure.

(The values shown above are for illustration purpose. Your meter may display different values depending on the settings & your environmental conditions)

7.8 P7.0: Conductivity or TDS Measurement Configuration

P7.1: READY Indicator and Auto-Endpoint Function

This program lets you select :

- “**READY Indicator On**” to indicate when the reading is stable.
- “**READY Indicator Off**” for faster meter response.
- **Auto-Endpoint Function On**. Select auto endpoint on to “hold” the reading when it is stable for more than 5 seconds. The display automatically freezes, and the HOLD indicator appears on the left side of the display. Press the HOLD key to release the display and access other functions.

From Measurement Mode :-

- 1 Press the **MODE** key to select conductivity or TDS measurement mode.
- 2 Press **SETUP** key to enter Set Up mode.
- 3 Press the **▲** or **▼** keys to scroll through subgroups until you view parameter P7.0.
- 4 Press **ENTER** key to select parameter 7.1.
- 5 Press the **▲** or **▼** keys to select the configuration you require.
 - OFF switches the READY indicator off;
 - ON switches the READY indicator on.
 - ON and HOLD together switches the auto endpoint feature on.
- 6 Press **ENTER** key to confirm selection and to proceed to Step 4 of P7.2. You can also press the **CAL/MEAS** key to return back to measurement mode.

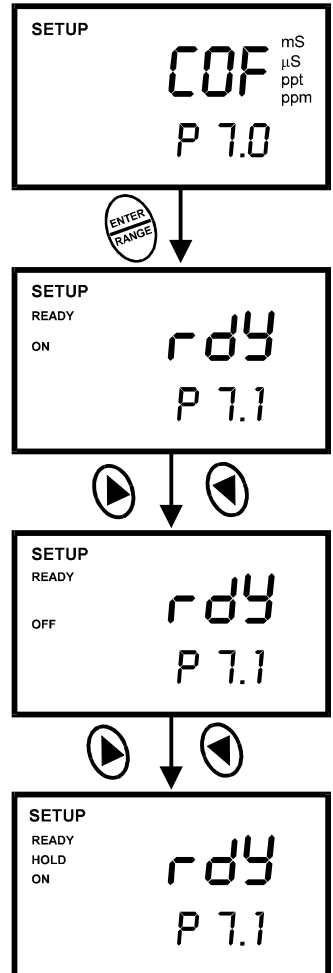

Figure 35 - Configuring the READY Feature

NOTE :

Meter default is set for Ready Indicator on, and auto endpoint function off.

P7.2 Selecting °C or °F

You can select between °C and °F units for temperature readings. Meter default is °C.

From Measurement Mode :-

- 1 Press the **MODE** key to select conductivity measurement mode.
- 2 Press **SETUP** key to enter Set-Up mode.
- 3 Press the **▲** or **▼** keys to scroll through subgroups until you view parameter P7.0.
- 4 Press the **ENTER** key two times to select parameter 7.2.
- 5 Press the **▲** or **▼** keys to toggle between °C and °F.
- 6 Press the **ENTER** key to confirm selection and to proceed to step 3 of P7.3. Press the **CAL/MEAS** key to return to measurement mode.

See Figure 37.

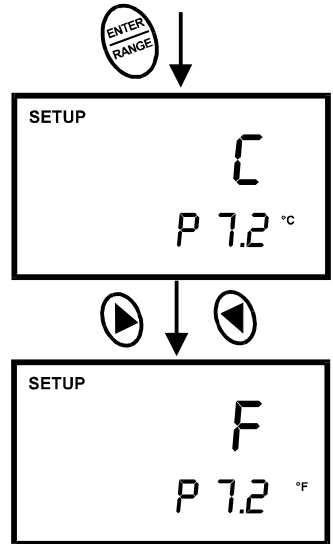

Figure 36 - Change Temperature Measurement Unit

NOTES:

- You can switch between °C and °F in Program P3.3 (available from pH mode). If you switch between °C and °F in conductivity mode, the meter will also switch in pH mode.

P7.3 Selecting Automatic or Manual Temperature Compensation

This feature lets you select between Automatic Temperature Compensation (ATC) and Manual Temperature Compensation. Meter default is ATC.

From Measurement Mode :-

- 1 Press the **MODE** key to select conductivity measurement mode.
- 2 Press **SETUP** key to enter Set Up mode.
- 3 Press the **▲** or **▼** keys to scroll through subgroups until you view parameter P7.0.
- 4 Press the **ENTER** key three times to select parameter 7.3. The upper display shows “ATC” and the lower display shows “P7.3”.
- 5 Press the **ENTER** key again. The upper display shows “ATC” and the lower display shows “YES” or “NO”.
- 6 Press the **▲** or **▼** keys to select the Automatic Temperature Compensation on or off.
 - YES = ATC on; NO = ATC off
- 7 Press the **ENTER** key to confirm selection and proceed to P7.4 next page. Press the **CAL/MEAS** key to return to measurement mode.

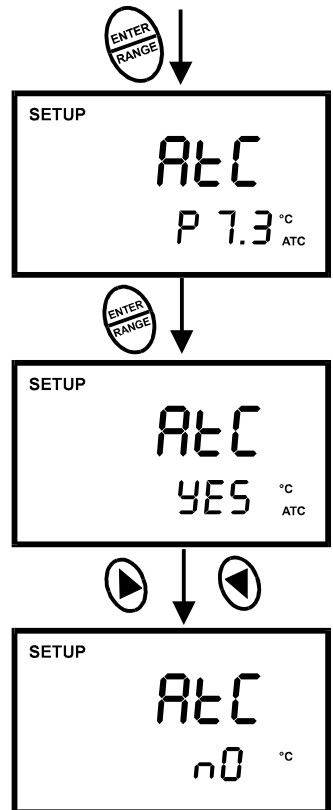

Figure 37 - Selecting ATC On or Off

P7.4 Setting the TDS factor

The concentration of salts dissolved in solution increases the conductivity of that solution. This relationship varies from salt to salt and is roughly linear over a given range for a given salt. The TDS conversion factor is the number used by the meter to convert from conductivity to TDS.

To Determine the Conductivity to TDS Conversion Factor for your Solution :-

Addendum 1 and 2 on this sheet describes the conversion factors and how to calculate the TDS conversion factor for other solutions.

You can set the TDS conversion factor between 0.4 and 1.0; meter default is 0.67.

From Measurement Mode :-

- 1 Press **SETUP** key to enter Set-Up mode.
- 2 Press the **▲** or **▼** keys to scroll through subgroups until you view parameter P7.0.
- 3 Press the **ENTER** key five times to select parameter 7.4. The upper display shows “tdS” and the lower display shows “P7.4”.
- 4 Press the **ENTER** key again. The upper display shows a value and the lower display shows “tdS”.
- 5 Calculate the TDS factor of your solution. See Addendum 2 on this sheet for information on how to calculate the TDS factor.
- 6 Press the **▲** or **▼** keys to select your calculated TDS conversion factor.
- 7 Press the **ENTER** key to confirm selection and to return to the subgroup menu. Press the **CAL/MEAS** key to return to measurement mode.

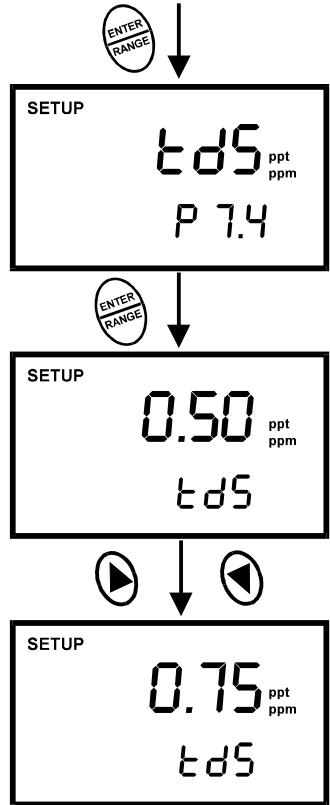

Figure 38 - Change of TDS Factor

7.9 P8.0 Temperature

P8.1 Selecting the Temperature Coefficient

The temperature coefficient is the amount of change in conductivity per degree of temperature; it is expressed in percent per °C. Entering the exact temperature coefficient of your solution lets you accurately compensate temperature for almost any solution *.

You can adjust 0.0 to 10.0 % per °C. Meter default is 2.1% per °C.

From measurement mode

- 1 Press the **MODE** key to select conductivity measurement mode.
- 2 Press **SETUP** key to enter Set Up mode.
- 3 Press the **▲** or **▼** keys to scroll through subgroups until you view parameter P8.0.
- 4 Press the **ENTER** key to select parameter 8.1. The display shows “t.CO” on the upper display.
- 5 Press the **ENTER** key again. The upper display shows the temperature coefficient and the lower display shows “t.CO”.
- 6 Press the **▲** or **▼** keys to select the temperature coefficient of your solution.
- 7 Press the **ENTER** key to confirm selection and to proceed to step 3 of P8.2. Press the **CAL/MEAS** key twice to return to measurement mode.

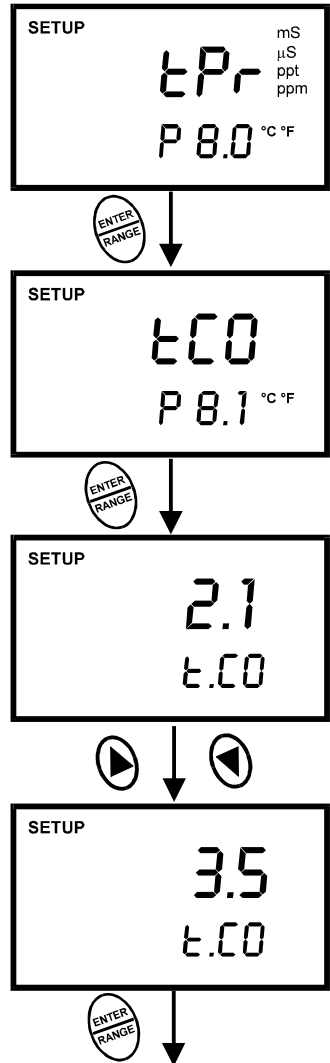

Figure 39 – Changing the Temperature Coefficient

NOTES :

* If you do not know the temperature coefficient of your solution you can determine the correct value using the formula in Addendum 3 “Calculating Temperature Coefficients” on Page 59.

P8.2 Adjusting the Normalization Temperature

Your meter will normalize its conductivity measurements to a standard temperature that you can select. You can adjust the normalization temperature from 15 to 30°C (59 to 86°F). Meter default is 25°C (77°F).

From Measurement Mode :-

- 1 Press the **MODE** key to select conductivity measurement mode.
- 2 Press **SETUP** key to enter Set Up mode.
- 3 Press the **▲** or **▼** keys to scroll through subgroups until you view parameter P8.0.
- 4 Press the **ENTER** key three times to select parameter 8.2. The display shows "t.nr" on the upper display.
- 5 Press the **ENTER** key again. The upper display shows the normalization temperature and the lower display shows "t.nr".
- 6 Press the **▲** or **▼** keys to select the normalization temperature.
- 7 Press the **ENTER** key to confirm selection and to return to the subgroup menu. Press **CAL/MEAS** key to return to measurement mode.

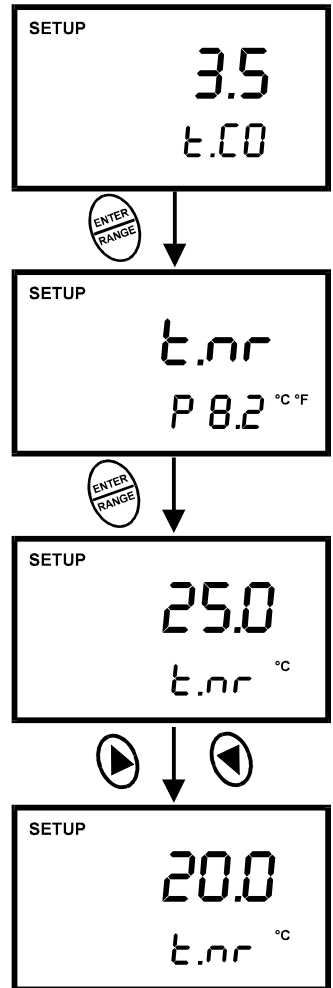

Figure 40 - Adjusting the Normalization Temperature

7.9.1 P9.0: Resetting to Factory Default Settings (Conductivity)

Program 9.0 lets you reset all parameters to factory default settings. This clears all calibration data and any other conductivity setup functions you might have changed.

From Measurement Mode :-

- 1 Press the **MODE** key to select conductivity measurement mode.
- 2 Press **SETUP** key to enter Set Up mode.
- 3 Press the **▲** or **▼** keys to scroll through subgroups until you view parameter P9.0.
- 4 Press the **ENTER** key to enter parameter P9.0.
- 5 Press the **▲** or **▼** keys to toggle between NO and YES.
 - NO retains current settings; YES resets to factory default settings.
- 6 Press the **ENTER** key to confirm selection and to return to the measurement mode. Otherwise press **CAL/MEAS** key to return to measurement mode without resetting to factory default.

See Figure 42.

NOTES :

To clear all pH data, see Page 40

See Addendum 4 on Page 61 for a table of factory default settings.

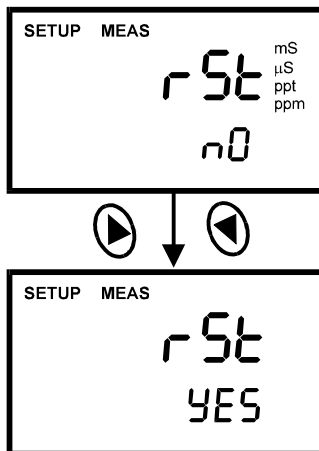

Figure 41 – P9.0: Reset to Factory Default Values

8 PROBE CARE AND MAINTENANCE

8.1 pH Electrode Care

Since your pH electrode is susceptible to dirt and contamination, clean it every one to three months depending on the extent and condition of use.

NOTE: For specialty electrode care, consult the instruction manual included with your electrode.

pH Electrode Storage

For best results, always keep the pH bulb wet. Use the protective electrode storage bottle or rubber cap filled with electrode storage solution to store your electrode. Also, you can store in a pH 4 buffer with 1/100 part of saturated KCl. Other pH buffers are OK for storage, but NEVER use distilled water for storage.

After Measuring

- 1 Rinse the pH electrode and reference junction in deionised water.
- 2 Store the electrode as recommended above in “pH electrode storage,” or as recommended by the manufacturer.
- 3 Prior to next use, rinse the liquid junction with deionised water and tap dry – never wipe electrode.

NOTE: If this does not restore electrode to normal response, see “Reactivating the pH electrode” section below.

pH Electrode Cleaning

- Salt deposits: Dissolve the deposits by immersing the electrode in tap water for ten to fifteen minutes. Then thoroughly rinse with distilled water.
- Oil/Grease film: wash electrode pH bulb gently in some detergent and water. Rinse electrode tip with distilled water or use a general purpose electrode cleaner (see ordering information).
- Clogged reference junction: Heat a diluted KCl solution to 60 to 80°C. Place the sensing part of the electrode into the heated solution for about 10 minutes. Allow the electrode to cool in some unheated KCl solution.
- Protein deposits: Prepare a 1% pepsin solution in 0.1 M of HCl. Set the electrode in the solution for five to ten minutes. Rinse the electrode with distilled water.

Reactivating the pH electrode

If stored and cleaned properly, your pH electrode should be ready for immediate use. However, a dehydrated bulb may cause sluggish response. To rehydrate the bulb, immerse the electrode in a pH 4 buffer solution for 10 to 30 minutes. If this fails, the electrode requires activation. Never touch or rub glass bulb. Contact builds up an electro-static charge.

pH Electrode Activation (for Glass Body Electrodes Only)

WARNING: Only qualified persons proficient with the safe handling of dangerous chemicals should perform the procedure below. Provide proper containers, fume hoods, ventilation, and waste disposal. Safety goggles and protective clothing must be worn while performing this procedure. If possible, replace with another electrode instead of performing this re-activation procedure.

- 1 Dip or stir the pH electrode in alcohol for 5 minutes.
- 2 Leave the electrode in tap water for 15 minutes.
- 3 Dip and stir the electrode in concentrate acid (such as HCl or H₂SO₄) for five minutes.
- 4 Repeat Step 2.
- 5 Dip and stir in strong base (NaOH) for five minutes.
- 6 Leave for 15 minutes in tap water.
- 7 Now test with standard calibration buffer solutions to see if the electrode yields acceptable results. You may repeat step 3 through 6 up to three times for better response. If the response does not improve, then your electrode is no longer functioning. Replace with a new electrode – call your distributor for information.

8.2 Conductivity Electrode

Keep the conductivity probe clean. Rinse the probe twice, and gently swirl it while you take readings. For best accuracy, soak a dry probe for at least 5 to 10 minutes or longer before calibration. Rinse the probe with deionised or tap water before storing. Never scratch the bands with a hard substance. Do not strike the probe against any hard surface.

Do not make continuous contact with your solutions. Readings will rise over a period of time while you soak your probe.

Do not immerse the probe in oily solutions. Clean the electrode thoroughly by stirring it in a mild detergent bath or isopropyl alcohol. Wipe the probe with a soft tissue paper. Rinse thoroughly in tap water and then in deionised water. Recalibrate the meter after cleaning the probe.

The conductivity probe (Order Part No. EC-CONSEN91W) which is included with your meter features a removable probe guard to make cleaning easy.

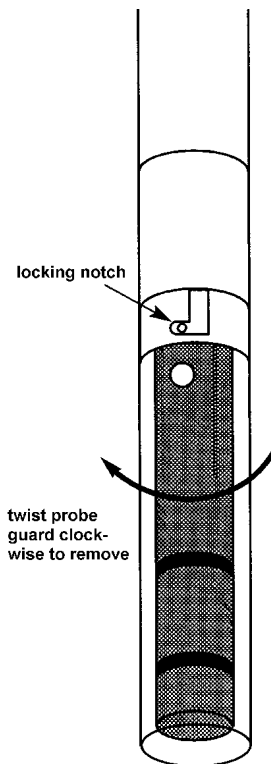

Figure 42 - Conductivity Probe, EC-CONSEN91W

To Remove Probe Guard :

- 1 Grip yellow probe guard and twist clockwise. The locking notch will release.
- 2 Slide probe guard off end of probe.

9 TROUBLE SHOOTING GUIDE

Problem	Cause	Solution
Press 'ON' key but no display	<ul style="list-style-type: none"> a) Batteries not in place b) Batteries not in correct polarity (+ and – position). c) Weak batteries 	<ul style="list-style-type: none"> a) Check that batteries are in place and making good contact. b) Re-insert batteries with correct polarity. c) Replace batteries.
Not responding to key press	<ul style="list-style-type: none"> a) HOLD mode in operation. b) Damaged key pad. c) Internal program error. 	<ul style="list-style-type: none"> a) Cancel HOLD mode by pressing Hold key. b) Return to dealer. c) Reset all internal programs by reinserting batteries.
Unstable readings	<ul style="list-style-type: none"> d) Air bubbles in probe. e) Dirty probe. f) Probe not deep enough in sample. g) External noise pickup or induction caused by nearby electric motor. h) Broken probe. 	<ul style="list-style-type: none"> d) Tap probe to remove bubbles. e) Clean the probe and re-calibrate. f) Make sure sample entirely covers the probe sensors. g) Move or switch off interfering motor. h) Replace probe.
"OR" on upper display	<ul style="list-style-type: none"> a) Probe is shorted. b) Probe is in an out-of-range solution. c) Broken probe. 	<ul style="list-style-type: none"> a) Test probe. Make sure probe is fully connected to meter. b) Use different solution. c) Replace probe. See "Accessories" on Page 56
Temperature reading erratic or lower display reads "OR"	<ul style="list-style-type: none"> a) Temperature of solution is out of range. 	<ul style="list-style-type: none"> a) Heat or cool solution.
Slow response	<ul style="list-style-type: none"> a) Dirty / Oily probe. 	<ul style="list-style-type: none"> a) Clean probe. See "Probe Care & Maintenance", page 50 – 52.

10 ERROR MESSAGES

LCD Display	Indicates	Cause	Solution
Err annunciator	Unrecognized input from keypad	Wrong input in selected mode.	Release key. Select valid operations depending on mode.
CAL & Err annunciators on / Buffer and electrode indicators blink.	Calibration error.	Wrong value input at calibration. Dirty probe.	Check your input value, clean probe. See Calibration sections or Probe Maintenance section.
Battery indicator blinks	Low battery level.	Need new batteries or battery connection is bad.	Clean battery contacts. Replace batteries with fresh ones, noting polarity.

If an error persists, or the meter shows incorrect values, return the meter. See “Warranty” and “Return of Items” on Pages 62 and 63.

For a complete diagram of the display see Page 2.

11 SPECIFICATIONS

Mode	pH	Temperature	Conductivity	TDS
Range	-2.00 to 16.00 pH	0.0 to 100.0 °C (32.0 to 212 °F)	0 to 19.99 µS 0 to 199.9 µS 0 to 1999 µS 0 to 19.99 mS 0 to 199.9 mS	0 to 9.99 ppm 0 to 99.9 ppm 0 to 999 ppm 0 to 9.99 ppt 0 to 99.9 ppt Max of 199.9 ppt based on factor setting
Resolution	0.01 pH	0.1 °C (0.1 °F)	0.01 µS 0.1 µS 1 µS 0.01 mS 0.1 mS	0.01 ppm 0.1 ppm 1 ppm 0.01 ppt 0.1 ppt
Accuracy	± 0.01 pH	± 0.5 °C (±0.5 °F)	±1% Full Scale + 1 digit	±1% Full Scale + 1 digit
Calibration	Up to five points (pH 1.68, 4.01, 7.00, 10.01, 12.45) with automatic buffer recognition	Offset in 0.1 °C increments	Up to five points (one point per range)	Up to five points (one point per range)
pH Slope & Offset Display	Yes			
Conductivity Cell constant (k)			1.0	1.0
Conductivity Temperature Coefficient			0.0 to 10.0 % per °C	0.0 to 10.0 % per °C
Normalization Temperature			15.0 to 30.0 °C (adjustable)	15.0 to 30.0 °C (adjustable)
Auto-ranging			Yes	Yes
Inputs	BNC	6-pin round connector	6-pin round connector	6-pin round connector
Temperature Compensation	Automatic / Manual from 0 to 80 °C			
Operating Temperature	0 to 50 °C			
HOLD function	Yes			
Averaging/Stability (READY)/Auto-hold	Yes			
Display	Custom Dual LCD			
Auto Power off	20 minutes after last key operation			
Power	four 1.5 V AAA-sized batteries (included)			
Battery life	>100 hours			
Dimensions / Weight	Meter: 19 cm (L) x 10 cm (W) x 6 cm (H); 320 g Case: 34 cm (L) x 40 cm (W) x 10 cm (H); 2.2 kg			

12 ACCESSORIES

Replacement Electrodes and Meter Accessories

pH

Ordering Code No.	Item
PT 110/1B	pH Electrode – Double Junction BNC Connector
PT 146/2	Combined pH/Temperature Electrode
PT 110/3B	ORP Electrode – Double Junction BNC Connector
PT 105/5	Buffer Pack pH 4/7/10
PT 105/8	Buffer Pack pH 7
PT 105/4	Electrode Care Pack (incl Electrode Storage Solution)
PT 105/12	Soil pH Access Set

Conductivity/TDS

Replacement Probes			
Standard Solutions for Conductivity/TDS		Conductivity	TDS
PT 146/1	Conductivity/TDS Probe with ATC Sensor, Stainless Steel ring type		
PT 142/2	High Range	12.88 mS	8.63 ppt (8630 ppm)
PT 142/3	Mid Range	1412 µS	946 ppm
PT 142/4	Low Range	74 µS	50 ppm

TDS value of standard solutions stated are based on a conversion factor of 0.67.

Temperature

PT 146/3	Temperature Probe (for use of instrument as stand-alone temperature meter)
----------	--

13 ADDENDUM 1: CONDUCTIVITY TO TDS CONVERSION FACTORS

The conductivity to TDS conversion factor is the factor the instrument uses to convert the electrical conductivity of the water sample to a total dissolved solids reading in ppm (mg/l). However the relationship between conductivity and TDS is empirical and no single conversion factor can give the correct result for every type of water sample. In practice the conductivity to TDS ratio depends on both the quantity and the nature of the ions in the water being tested.

The conversion factor most commonly applied for use with TDS meters is 0.67. This is the factory set conversion factor used when setting up this instrument. This factor is the one which most closely represents the relationship between conductivity and total dissolved solids for natural water samples.

When testing water samples of other types it may be appropriate to use a different conversion factor based on practical knowledge of the sample or recommendations given from other sources. For example when working with samples containing high proportions of sodium chloride (salt) or potassium chloride then a lower conversion factor of say 0.55 would be more appropriate. This is the factor which could be used, for example, when checking salt water swimming pools, ie swimming pools which have had salt added to them for aesthetic effect or to allow the use of electrolytic chlorine generators.

Palintest conductivity/TDS standard solutions (see Page 56) give TDS values for conversion factors of 0.67, and for values of 0.70, 0.55 and 0.50.

The meter may be set using conductivity solutions or TDS solutions of other values as required to suit individual TDS requirements.

14 ADDENDUM 2: CALCULATING TDS CONVERSION FACTORS

You can calibrate your meter using home-made or commercially available TDS or conductivity calibration standard solutions. The calibration standard only needs to give the TDS or conductivity value at a standard temperature such as 25°C. To determine the conductivity-to-TDS conversion factor use the following formula:

$$\text{Factor} = \frac{\text{Actual TDS}}{\text{Actual Conductivity}} @ 25^{\circ}\text{C}$$

Definitions :

- **Actual TDS:** Value from the solution bottle label or as a standard you make using high purity water and precisely weighed salts.
- **Actual Conductivity:** Value from the solution bottle label or value measured using a properly calibrated Conductivity/Temperature meter.

Both the Actual TDS and the Actual Conductivity values must be in the same magnitude of units. For example, if the TDS value is in ppm the conductivity value must be in μS ; if the TDS value is in ppt the conductivity value must be in mS.

Check your factor by multiplying the conductivity reading by the factor in the above formula. The result should be in TDS value.

15 ADDENDUM 3: CALCULATING TEMPERATURE COEFFICIENTS

To determine the temperature coefficient of your sample solution use this formula :-

$$tc = 100 \times \frac{C_{T_2} - C_{T_1}}{C_{T_1}(T_2 - 25) - C_{T_2}(T_1 - 25)}$$

Where:

tc = Temperature coefficient	25 = 25°C
C_{T1} = Conductivity at Temp 1	C_{T2} = Conductivity at Temp 2
T₁ = Temp 1	T₂ = Temp 2

NOTE: A controlled temperature water bath is ideal for this procedure.

- 1 Immerse the probe into a sample of your solution and adjust the temperature coefficient to 0% (that is, no compensation) by performing the following:
 - A From measurement mode, press the **SETUP** key to enter Setup mode.
 - B Press the **▲** or **▼** keys until the lower display reads P8.0.
 - C Press the **ENTER** key twice. The lower display reads tCO and the upper display shows the temperature coefficient value.
 - D Press the **▼** key until the upper display shows 0.0.
 - E Press **ENTER** key to confirm the value.
 - F Press **CAL/MEAS** key twice to return to measurement mode.
- 2 Wait for 5 minutes. Note **T₁** and **C_{T1}** (conductivity at **T₁**).
- 3 Condition the sample solution and probe to a temperature (**T₂**) that is about 5°C to 10°C different from **T₁**, and note the conductivity reading **C_{T2}**.

NOTE: Record your results for future reference. Ideally **T₁** and **T₂** should bracket your measurement temperature, and should not differ by more than 5 °C.

- 4 Calculate the temperature coefficient of your solution according to the formula shown above.
- 5 Enter the temperature coefficient you calculated into the meter.
 - A From measurement mode, press the **SETUP** key to enter Setup mode.
 - B Press the ▼ key until the lower display reads P8.0.
 - C Press the **ENTER** key twice. The lower display reads tCO and the upper display shows the temperature coefficient value (should be 0, as per step 1 above).
 - D Press the ▲ key until the upper display shows your calculated temperature coefficient.
 - E Press **ENTER** key to confirm the value.
 - F Press **CAL/MEAS** key twice to return to measurement mode.

The calculated temperature coefficient will not be applied to all the meter readings.

16 ADDENDUM 4: METER FACTORY DEFAULT SETTINGS

Resetting the meter to factory default settings clears all calibration data and most other setup functions you might have changed. The following settings will remain as you have set them:

- Temperature unit of measure (°C or °F)
- The temperature offset calibration value.

NOTE: Conductivity and pH data are cleared separately from each other.

- To clear pH data, see Sub group P4.0 on Page 40
- To clear conductivity/TDS data, see Sub group P9.0 on Page 49

Type	Parameter	Default	Remarks
pH parameters			
P1.1	View pH calibration data	—	No calibration data for 1 st buffer, pH 1.68
P1.2		—	No calibration data for 2 nd buffer, pH 4.01
P1.3		—	No calibration data for 3 rd buffer, pH 7.00
P1.4		—	No calibration data for 4 th buffer, pH 10.01
P1.5		—	No calibration data for 5 th buffer, pH 12.45
P2.1	View electrode offset	0.00 mV	No offset adjustment
P2.2	View electrode slope	100.0%	No slope adjustment
P3.1	Ready indicator	Ready On	Ready indicator on; auto endpoint off
P3.2	# pH calibration points	3	3 pH calibration points available (1 – 5 pt range)
P3.3	°C or °F	No default	°C or °F remains as selected
P4.0	pH factory default	No	Retains your current settings
Conductivity and TDS parameters			
P5.1	Viewing conductivity or TDS calibration data	—	No calibration data for range 1 (see page 11)
P5.2		—	No calibration data for range 2 (see page 11)
P5.3		—	No calibration data for range 3 (see page 11)
P5.4		—	No calibration data for range 4 (see page 11)
P5.5		—	No calibration data for range 5 (see page 11)
P6.1	Viewing conductivity or TDS Calibration data	1.0	No offset for effective cell constant for range 1.
P6.2		1.0	No offset for effective cell constant for range 2
P6.3		1.0	No offset for effective cell constant for range 3
P6.4		1.0	No offset for effective cell constant for range 4
P6.5		1.0	No offset for effective cell constant for range 5
P7.1	Ready indicator	Ready On	Ready indicator on; auto endpoint off
P7.2	°C or °F	No default	°C or °F remains as selected
P7.3	ATC on or off	ATC on	—
P7.4	TDS factor	0.67	Adjustable from 0.4 to 1.0
P8.1	Temperature coefficient	2.1% per °C	Adjustable from 0 to 10%
P8.2	Normalization temperature	25 °C	Adjustable from 15 to 30 °C
P9.0	Conductivity factory default	No	Retains your current settings

17 WARRANTY & RETURN OF ITEMS

Palintest instruments are guaranteed for a period of one year from the date of purchase. The dissolved oxygen probe is guaranteed for a period of six months from date of purchase.

These guarantees exclude accidental damage or damage caused by misuse or unauthorised repair. The guarantee also excludes damage caused by chemical solutions or operation outside the environmental specifications for the product.

Return of Items

Should repair be necessary, contact Palintest Instrument Service Department or an authorised distributor. Authorisation in the form of a Product Return Note (PRN) must be obtained from Palintest Instrument Service Department before returning meters for repair under guarantee. Meters being returned must be sent freight-paid. Items should be packed carefully to prevent damage in transit and insured against possible damage or loss. Palintest will not be responsible for any damage resulting from loss in transit or inadequate packing.

NOTES :

Date	Time	Recorded Value	Remarks

For more information on Palintest products, contact your nearest Palintest distributor or visit our website listed below :

Palintest Ltd

Palintest House, Kingsway, Team Valley, Gateshead, Tyne & Wear NE11 0NS England

Tel: 0191 491 0808 Fax: 0191 482 5372
E.Mail: palintest@palintest.com Website: www.palintest.com

The information in this booklet is believed to be correct but is given without warranty or engagement. Palintest reserves the right to make improvements in design, construction and appearance of the products. Specifications are subject to change without notice. Illustrations are for style only, individual products may vary slightly from those described.