



Frontier™ 5706

Multi Centrifuge



Reliable and Compact Multi-Function Centrifuge For Standard Life Science Separation Applications

Frontier™ 5706 is a small benchtop multi-function centrifuge ideal for a multitude of spin-down applications. Characterized by reliability, various safety features, the ability to accommodate test tubes of various sizes and intuitive operation, Frontier 5706 was built to meet the basic need for liquid separation in the life sciences.

Standard Features Include:

- **Extremely Simple and Intuitive Operation**—With an easy-to-turn control knob, a large LCD display and the capabilities to set and view both speed in rpm and g-force, obtain precise results and enhanced functionality from this easy-to-use centrifuge.
- **Compatibility with Test Tubes of Various Sizes**—Frontier 5706 can accommodate all standard tube sizes from 1.5 mL to 50 mL, providing centrifugation for a wide variety of applications. It also has a large capacity, and can hold six 50 mL tubes and twelve 15 mL tubes during one process.
- **Several Safety Features that Protect Against Injury**—Among Frontier 5706's safety attributes are a sturdy mechanical lid with locking system and a rotor imbalance sensor that stops the centrifuge if the rotors become imbalanced or sudden shock occurs, protecting the operator from being injured by the high-speed spinning rotors.

Frontier™ 5706 Multi Centrifuge

Model	FC5706	
Speed Range	200 rpm – 6000 rpm; 50 rpm/increments	
Maximum RCF	4427 x g; 10 x g/set	
Maximum Capacity (Rotor)	6 x 50 mL	
Cooling	Air Cooled	
Running Time	10 sec to 99 hr 99 min 99 sec or Continuous	
Noise Level (Depending on the Rotor)	≤ 60 +2 dB(A)	
AC Power	230 V/50 – 60 Hz	120 V/50 – 60 Hz
Voltage Fluctuation	± 10%	± 10%
Current Consumption	0.55 A	1.1 A
Power Consumption	100 W	100 W
Dimensions (W × D × H)	291 × 392 × 266 mm	
Net Weight (Without Rotor)	10.5 kg	
Shipping Dimensions (W × D × H)	400 × 545 × 410 mm	
Shipping Weight (Without Rotor)	15 kg	

Approvals

- **Product Safety:** EN 61010-1:2010, EN 61010-2-020:2006
- **Electromagnetic Compatibility:** EN 61326-1:2006, FCC Part 15 Class B

Dimensions

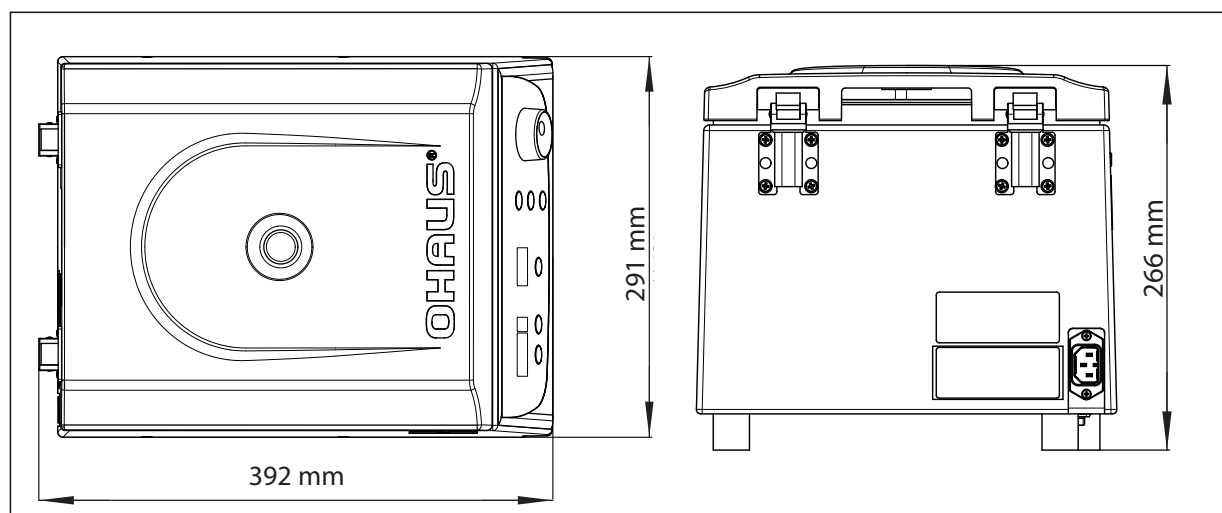





Frontier™ 5706 Rotors and Adapters









Rotors and Adapters that Expand the Versatility of Frontier FC5706

Various rotors and tube adapters provide FC5706 with the ability to hold tubes of different sizes and capacities.

				
Item	Angle Rotor, 12 × 15 mL	7mL Tube Adapter	5ml Tube Adapter	1.5 mL/2.0 mL Tube Adapter
Camlab Item Number	1207244	1207345	1207346	1207353
Compatible Tubes	15 mL	7 mL	5 mL	1.5mL / 2.0mL
Maximum Number of Tubes	12	12	12	12
Max. RPM	6000 rpm	6000 rpm	6000 rpm	6000 rpm
Max. RCF	4427 × g	4265 × g	3621 × g	3058 × g
Radius	110 mm	106 mm	90 mm	76 mm
Type	Angle Rotor ∠32°		—	
Rotor Material	PP ¹		—	

Frontier™ 5706 Rotors and Adapters

					
Item	Angle Rotor, 6 x 50 mL	30 mL Tube Adapter	16 mL Tube Adapter	15 mL Tube Adapter	15 mL RB/ Falcon Tube Adapter
Camlab Item Number	1207245	1207347	1207348	1207349	1207350
Compatible Tubes	50 mL	30 mL	16 mL	15 mL	15 mL RB/Falcon
Maximum Number of Tubes	6	6	6	6	6
Max. RPM	6000 rpm	6000 rpm	6000 rpm	6000 rpm	6000 rpm
Max. RCF	4427 x g	4306 x g	4145 x g	4225 x g	4185 x g
Radius	110 mm	107 mm	103 mm	105 mm	104 mm
Type	Angle Rotor $\angle 40^\circ$				
Rotor Material	PP ¹				

	
Item	Swing Out Rotor, 6 x 5 mL
Item Number	1207266
Compatible Tubes	5 mL
Maximum Number of Tubes	6
Max. RPM	6000 rpm
Max. RCF	1878 x g
Radius	105 mm
Type	Swing Out Rotor
Rotor Material	Aluminium

	
Item	Replaceable Buckets, For Swing Out Rotor (2 PCS/Package)
Item Number	1207282

Notes:

1. PP: Polypropylene

OHAUS Europe GmbH

Im Langacher 44
8606 Greifensee
Switzerland

e-mail: ssc@ohaus.com

Tel: 0041 22 567 53 19

e-mail: tsc@ohaus.com

Tel: 0041 22 567 53 20

www.ohaus.com

OHAUS Corporation is an
ISO 9001:2008 manufacturer,

ISO 9001:2008

Registered Quality
Management System

