



# *Fuego*<sup>SCS</sup> *pro*

**Safety Enhanced  
Laboratory Gas Burner**





Fig. A

- 1 - Function knob
- 2 - Gas- / Air adjustment
- 3 - Graphic display
- 4 - Residual heat display
- 5 - IR-Sensor
- 6 - Burner head
- 7 - Flame orifice

- 8 - Connector for foot pedal
- 9 - Power connector
- 10 - Gas inlet R 1/4" L gas adapter (left hand thread)
- 11 - Holding device for inoculation loop holder



Fig. B



Fig. C

- 12 - Burner head screw
- 13 - Monitor electrode
- 14 - Ignition electrode

- 15 - Active nozzle
- 16 - Nozzle holder with nozzle for alternative gas
- 17 - Cover of the burner shaft
- 18 - Retaining screw for cover of the burner shaft

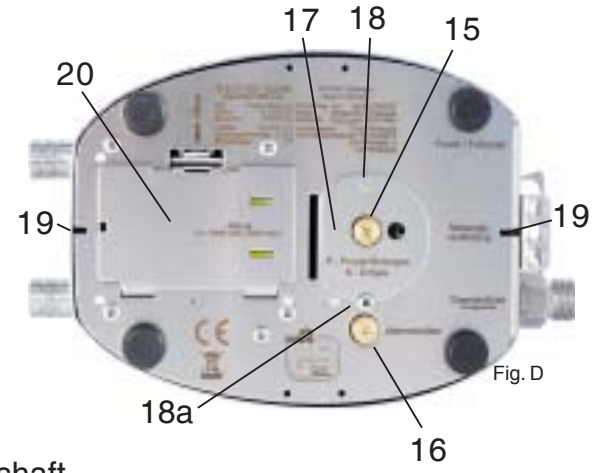

Fig. D

- 18a - Position screw for the cover
- 19 - Guide slots for tilt adjustment
- 20 - Battery compartment cover
- 21 - 2 x Mignon rechargeable batteries (AA)

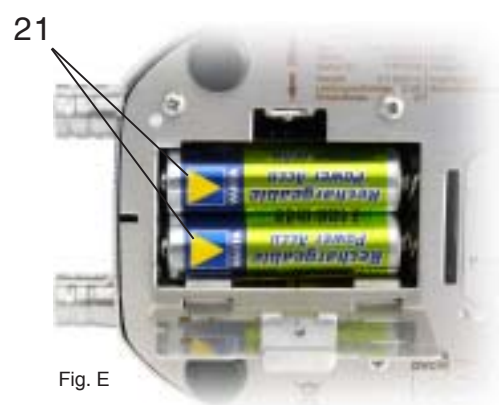

Fig. E

# Table of contents

Use .....	5
Safety Precautions .....	5
The range .....	8
1. Set up .....	9
1.1 Choice of nozzle .....	9
1.2 Gas connection .....	9
1.3 Mains power supply .....	10
1.4 Foot pedal connection .....	10
1.5 Rechargeable NiMH batteries - transportation lock .....	10
2. Operation .....	12
2.1 Switching on for the first time .....	12
2.2 Switching on, selecting user .....	12
2.3 Menu navigation .....	12
2.4 Flame regulation .....	13
2.5 Switching off the unit .....	13
2.6 Internal charging function, battery symbol .....	14
3. Application programs .....	15
3.1 Button Start-Stop .....	15
3.2 Sensor Auto-Off .....	15
3.3 Sensor Start - Stop .....	16
3.4 Pedal Standard .....	17
3.5 Pedal Start-Stop .....	17
3.6 Temperature regulation .....	17
3.6.1 Safety stop for temperature regulation program .....	18
4. Reminder function menu .....	19
4.1 Cooling time reminder .....	19
4.2 Gas consumption display .....	19
4.2.1 Reminder of gas consumption .....	20
4.2.2 Resetting the gas consumption display .....	20
5. Settings .....	21
5.1 BHC, Burner Head Control .....	21
5.2 IR-Sensor .....	21
5.3 Stand-by time .....	23
5.4 Brightness / Contrast .....	23

5.5 Buzzer .....	23
5.6 Information menu .....	24
5.7 Factory default settings .....	24
5.8 Exiting the settings menu .....	25
<b>6. Safety warning display .....</b>	<b>26</b>
6.1 Residual heat display .....	26
6.2 Burner head control (BHC, Burner Head Control) .....	26
6.3 Battery monitoring .....	26
<b>7. Error Display .....</b>	<b>27</b>
7.1 Ignition failure .....	27
7.2 Overtemperature .....	27
7.3 BHC - Time limit active .....	27
7.4 Burner head assembly monitor .....	28
7.5 Tilt sensor .....	28
<b>8. Battery replacement / using an external battery charger .....</b>	<b>28</b>
<b>9. Cleaning and sterilizing .....</b>	<b>29</b>
9.1 Burner head disassembly and cleaning .....	29
9.2 Burner shaft cleaning .....	29
<b>10. Turbo flame .....</b>	<b>30</b>
<b>11. Tilt adjustment .....</b>	<b>30</b>
<b>12. Warranty .....</b>	<b>30</b>
<b>Technical data .....</b>	<b>31</b>
<b>Enclosure 1: Installation and Operating Instructions .....</b>	<b>32</b>
<b>Enclosure 2: Recommended rechargeable batteries .....</b>	<b>33</b>
<b>Trouble shooting guide .....</b>	<b>35</b>
<b>Structure of menu .....</b>	<b>38</b>

Read these instructions carefully to familiarize yourself with the product. Please retain these operating instruction for future reference.

## Use

Safety laboratory gas burners for heating and flame sterilizing. Ideal for use in cleanroom workbenches and laboratory.



**All users who have been assigned to use this device must have read and understood these operating instructions or have been instructed by an expert user so that this device can be used safely without causing danger.**

## Safety Precautions

- On unpacking the unit, check for possible transportation damages. Do not operate the unit if damages are visible.
- After use or for any longer period of time without attendance, turn the main gas supply off and turn off the gas burner at the function knob (1).
- All gas connections must be adequately tightened (left-hand thread). Ensure gas proofness with suitable test equipment. **DO NOT** seal the swivel nut on the safety laboratory gas burner (10) with Teflon tape, etc.
- **BEFORE** using the device carefully check the gas feed tube for leaks. Check this even if the device has been installed by your distributor. To do this, carry out all the procedures mentioned in these operating instructions (see paragraph 1.2).
- In the event that gas can be smelled: immediately turn off the gas supply to the device. Extinguish any open flames. Pull out the mains plug and remove batteries. Check all gas connections for gas proofness. If the smell of gas persists, the appropriate authorities must be notified (janitor, gas utility company, Fire Brigade).  
**LEAKING GAS CAN CAUSE A FIRE OR AN EXPLOSION. THIS MAY RESULT IN SEVERE INJURIES, FATAL ACCIDENTS AND DAMAGE TO PROPERTY.**
- The device can be dangerous if operated or used in an incorrect manner by untrained staff.
- An incorrect gas connection may create a hazard. Observe the installation instructions in the manual.
- Do not store spare or unconnected gas cartridges / gas bottles in the vicinity of this device.
- Even in an apparently empty gas cartridge/gas bottle, some gas may still remain. Gas cartridges/gas bottles should be transported and stored accordingly. Empty gas cartridges should be properly disposed.
- Do not use the device if there is a smell of gas or if there is a leak.
- **NEVER** try to loosen or unfasten gas connections while the gas supply is turned on and the device is in operation.

- Pay attention to your relevant rules for using liquid gas.
- Only use DVGW safety tubings with thread or tubing connectors. Check the condition of the tube/hose frequently. Depending upon type of tube/hose, hose clamps are required.
- NEVER use a open flame to look for leaks.
- Do not smoke if you are searching for leaks.
- Keep hands or other parts of the body away from the burner orifice (7).
- Do not operate the unit near flammable liquids or hazardous materials.
- Unattended operation of the unit is not permissible.
- Always work in a well-ventilated area.
- Note that the burner orifice (6,7) remains hot after the flame has been extinguished. Do not touch. Can cause burns.
- Allow sufficient time for flame orifice (7) to cool down prior to cleaning, disinfecting, servicing or transport. Ensure that the unit and the gas supply are turned off.
- Because of the connectors at the back of the unit the backside should not be sterilized with a flame.
- Allow sufficient time for burner head (6) to cool down prior to disassembling.
- Operate the unit with assembled burner head (6) only.
- After cleaning the burner head (6) allow sufficient time to dry before assembling again.
- Do not allow anything to fall into the flame orifice (7).
- Before mounting a nozzle check the O-Ring (22). Replace the O-Ring if damaged or worn (see paragraph 1.1).
- When working with this device, always wear protective glasses.

#### **Use- and warning instructions of NiMH rechargeable batteries and the integrated charging function**

- Insert only the recommended, rechargeable batteries (Page 33), i.e., no other battery type and no non-rechargeable batteries, because health hazards and physical injuries cannot be ruled out otherwise.
- Rechargeable batteries should not be disposed with household garbage. Please comply with the local waste disposal provisions, which can be obtained from your community, your dealer or the person from whom you purchased the product.
- The charging time can increase, if the device is heated after a long burning period. The charging electronic system is equipped with a temperature sensor which prevents charging at high temperatures.
- Do not short-circuit the battery contacts.
- Do not throw the battery into the fire (danger of explosion).

- **Observe the charging specifications of the battery manufacturer! Use the integrated charging function only for batteries of large capacity from 2000 mAh onwards. The charging current of the integrated charging electronic system of the device is 700 mA.**
- **Use 2 rechargeable batteries of the same type only! Otherwise the battery may explode, leak or become hot, causing injury.**
- **If the device has come into contact with liquid: Turn the main gas supply off. Turn off the gas burner at the function knob (1) and remove the rechargeable batteries immediately. Before further use place the device in a dry warm place for at least 72 hours (not in a microwave, oven, etc!)**
- **Keep rechargeable battery contact surfaces and rechargeable battery compartment contacts clean by rubbing them with a wet cotton swab. Clean carefully and do not damage the contacts.**
- **During the fast charging process the rechargeable batteries can heat up to 50°C.**
- **Remove batteries from a device when it is not expected to be in use for more than one year.**
- **Extremely exhaustive discharged batteries cannot be charged. Use external charging station.**
- **Before replacing the battery ensure that the unit and the gas supply are turned off.**
- **The instructions for the battery disposal in Enclosure 3 must be observed**

## The range

### Fuego SCS pro

Art.-No. 8.004.000

includes IR-Sensor and graphic display, 6 standard-programs for IR-Sensor, foot pedal, button (function knob) and temperature regulation

2 Mignon(AA), **(R6)** rechargeable batteries already inserted in the battery compartment

Adjustable IR-Sensor reaction distance and DoubleClick IR-Sensor (connectable)

SCS (Safety Control System)

BHC (Burner Head Control)

Removable and decomposable burner head

Tilt mechanism, right / left **(R1)**

Holding device for 3 inoculation loop holders **(11)**

Nozzles for natural gas, propane/butane gas

Turbo flame

Wrench 17 mm **(R2)** for gas connection

Screwdriver **(R3)** for burner head and cover of the burner shaft

Tubing connector with swivel nut for 10mm pipe spout tubing **(R4)**

Power connection with 4 adapter **(R5)**

Instruction manual

2-year warranty

#### Optional:

**Foot pedal (see paragraph 1.4)**





## 1. Set up

Initial operation is to be carefully carried out as described in the following paragraphs.

 Failure to observe the instruction manual **may give rise to hazards from leaks and / or bursts of flame.**

### 1.1 Choice of nozzle

**The unit is shipped with the nozzle for natural gas (N, 08) installed. The nozzle for propane / butane (P, 06) can be found in the nozzle holder (16).**

The nozzle on the device must be fitted or the gas type in use, in which case proceed as follows:

On the bottom of the device, remove the nozzle **P, 06** for propane / butane by unscrewing it from the nozzle holder (**16**) with a coin (1 Cent coin) or the screwdriver (**R2**). Then remove the active nozzle **N, 08** for natural gas (**15**) (preinstalled) and exchange the nozzles. Tighten both nozzles again after changing over.

 Each time before mounting a nozzle, check the O-ring (**22**) for damage. **Replace O-ring if damaged, Art. No.: 8.000.010**



### 1.2 Gas connection

Connect the device via the gas inlet (**10**) to the gas supply, if the operating pressure for natural gas is 18-25 mbar, for propane/butane 47-57 mbar. Only use DVGW or other gas approved safety tubing with thread or tubing connectors.

Check the condition of the tube/hose regularly. Depending on the type of hose, hose clips and/or the hose clamps and the swivel nut included (**R4**) are to be used.

A DVGW tested or other gas approved pressure regulator (50mbar) must be used for liquid gas. **Pay attention to your relevant rules for using liquid gas.**

If using gas cartridges, use only an original WLD-TEC gas cartridge adapter! Observe the operating instructions in question for the gas cartridge adapter.

If using the tubing connector and swivel nut (**R4**) included, **DO NOT** seal up the gas connection (**10**) to the Fuego with Teflon tape, etc.



 All gas connections must be adequately tightened with a wrench SW17 **(R2)** (included in delivery). Note: left-hand thread. Check gas proofness with testing equipment or soapy water. To do this with the gas supply turned on, wet the gas connections with test solution or soapy water and look for bubbles. If bubbles form or if one bubble becomes larger, there is a leak. Immediately turn off the gas supply.

Check all gas supply connections or gas joints (e.g.: at the gas cartridge/gas bottle, at the laboratory gas burner or at an additional gas leak protection).

In the event of leaks, tighten up the gas joints with a wrench and test again for gas proofness. **Never use an open flame to look for leaks.**

### 1.3 Mains power supply

Plug the power cable into the socket **(9)** on the back of the unit or into the socket on the foot pedal. The mains power supply unit included is designed for a voltage from 100 - 240 V, 50/60 Hz. The mains power supply unit may only be connected if these values comply with the intended electricity supply. Before using it, push the corresponding socket adapter onto the mains power supply plug (see Instruction sheet "Mains power supply").

### 1.4 Foot pedal connection

Insert the connection cable of the foot pedal into the socket **(8)** at the back of the unit. The foot pedal is an optional accessory.

 If no pedal is connected, the symbol for connecting appears in the Pedal - Application Programs. On the display a foot pedal and the automatic inoculation loop carousel Autoloop Pro are displayed.

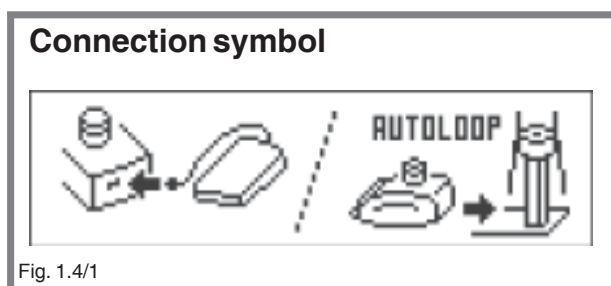

#### Available Foot pedal / Benchtop switch

Foot pedal made of stainless steel:

**Art.-No.: 6.000.402**

Foot pedal Mini made of plastic:

**Art.-No.: 6.000.403**

Benchtop switch:

**Art.-No.: 6.000.405**

Wireless radio frequency foot pedal (EU-countries only):

**Art.-No.: 8.000.404-RF**

#### Automatic carousel for flame sterilising:

Autoloop Pro

**Art.-No.: 8.000.400**

Additional information at [www.wld-tec.com](http://www.wld-tec.com).

### 1.5 Rechargeable NiMH batteries - transportation lock

The NiMH rechargeable batteries included in the delivery are already charged and inserted in the battery compartment **(20)** for operation independently of the mains power supply. To operate the device with the batteries, just remove the transportation lock

(20a) in the direction of the arrow.

**i** The rechargeable batteries will be discharged to a certain extent after long storage periods. Hence, under certain circumstances, the full number of operating hours may not be achieved during initial use. Please recharge the batteries if necessary after long storage periods (**see paragraph 2.6 & 8**).

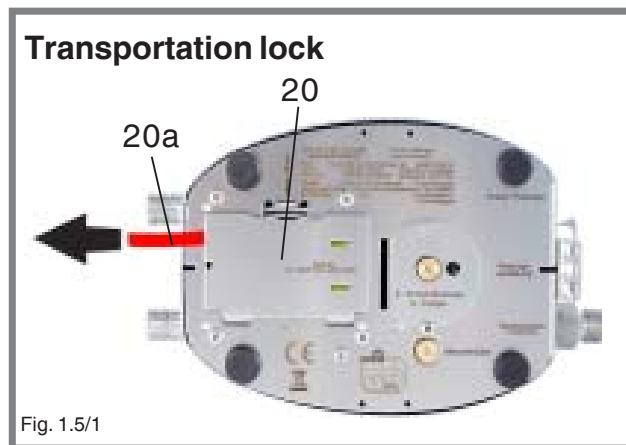

## 2. Operation

This Section describes the operation of the unit with the function knob and the gas/air adjustment, as well as the functioning of the internal charging function.

### 2.1 Switching on for the first time

Switch the unit on by a short push on the function knob **(1)**. After switching on, Installation and Operating Instructions appear before the device can be used for its intended purpose. These instructions can be switched forward every time by a short push on the function knob (for a Summary of the Instructions see Appendix 1).

The installation and operating instructions end with the display how to use the gas / air knob.

Subsequently the unit switches over automatically to the user selection function, just as when switching on normally on later occasions.

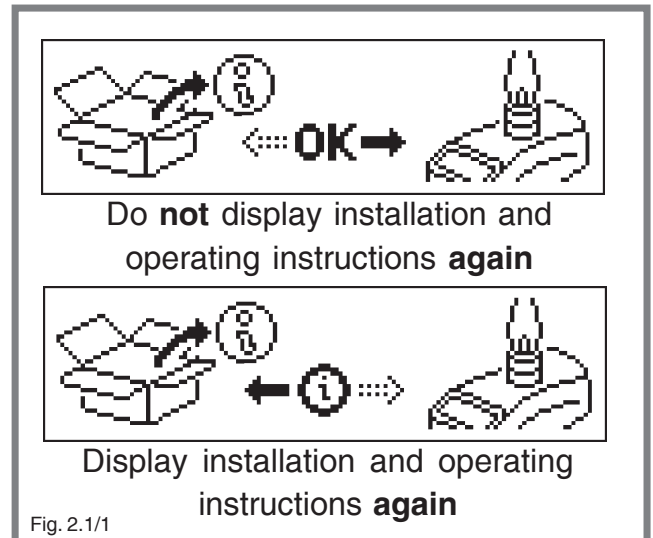

**i** The next five times the unit is switched on, the user can select whether the installation and operating instructions are to be displayed once again or whether installation has been successfully carried out. **Once confirmation has been given that the installation and operating instructions have been successfully concluded, the request for confirmation is no longer displayed.**

### 2.2 Switching on, selecting user

The unit is switched on by a short push on the function knob **(1)**. After switching on, within a few seconds the selection between “User 1” or “User 2” can be made by turning the function knob **(1)**. **Selecting the user account always takes place only when switching on the unit.** To change user, switch the unit off and back on again.

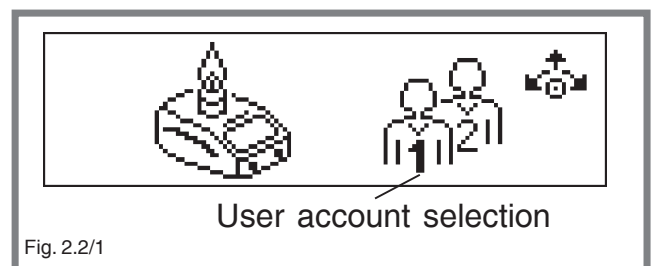

**i** Both user accounts save all burning times, settings, parameters and the application program last used depending on user.

### 2.3 Menu navigation

Navigating through the function menu and the settings of various parameters is carried out using only the function knob **(1)**. Depending on the arrows on the graphic display, all menu items can be selected and exited by turning or pushing this knob.

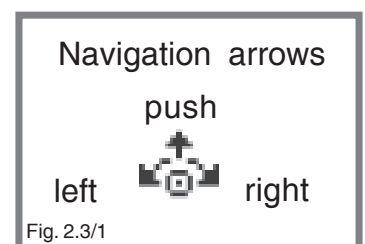

The arrows on the Display indicate in which direction the next menu items are accessible. If a submenu is selected by pushing the knob, the arrow blinks and also the parameter or alternatively the time which is to be set. The parameter or time can now be varied by turning the function knob.

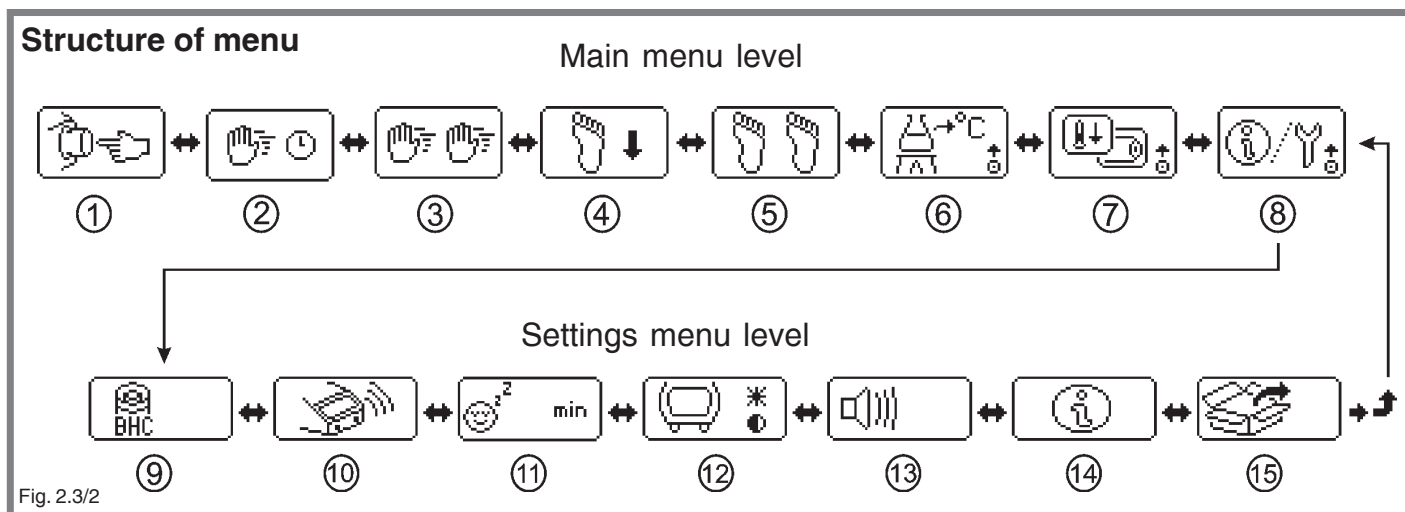

#### Main menu level:

- 1 - Application prog. Button Start - Stop
- 2 - Application prog. Sensor Auto - Off
- 3 - Application prog. Sensor Start - Stop
- 4 - Application prog. Pedal Standard
- 5 - Application prog. Pedal Start - Stop
- 6 - Operation mode: Temperature regulation program
- 7 - Reminder function menu
- 8 - Settings menu

#### Settings menu level:

- 9 - Burner Head Control (BHC)
- 10 - IR - Sensor settings
- 11 - Stand-by
- 12 - Brightness / Contrast
- 13 - Buzzer on / off
- 14 - Basic unit data
- 15 - Factory default settings

## 2.4 Flame regulation

The flame can be varied in size and intensity by turning the gas / air knob **(2)**. Regulating the size of the flame is done by turning the gas / air adjustment. Regulating the air intake for the flame intensity is carried out by **pulling outwards and at the same time rotating** the gas / air adjustment.

 When using for the first time or changing the gas type, turn the gas / air adjustment knob two revolutions to the left. Then pull the gas / air adjustment outwards and simultaneously turn it one revolution to the left to open the air intake.

## 2.5 Switching off the unit

The unit can be turned off by a long push (2 seconds +) on the function knob. During switching off, the device follows a "Zero Pressure" procedure to lower the pressure in the supply hose.

After a long push of more than 2 seconds, the device thus starts an animated display to remind you to turn off the gas supply and reduce the gas pressure from the supply hose.

To do this, press the function knob **(1)** briefly during the switch off routine once again to start

the ignition of the unit and to burn off the residual gas in the hose.

**!** **The FLAME IGNITES! Ensure you turn off the gas supply BEFORE actuating the knob during the switch off routine!**

The entire procedure takes approx. 15 seconds. Thereafter, the unit switches off of its own accord. If the function knob is not pressed during the animated display, the unit switches off after approx. 10 seconds on its own.

**i** If the function knob is not actuated during the switch off routine, the supply hose is still under pressure! The switch-off routine can be curtailed if, during the animated display, the function knob is pressed for longer than 2 seconds. Then the device switches off immediately.

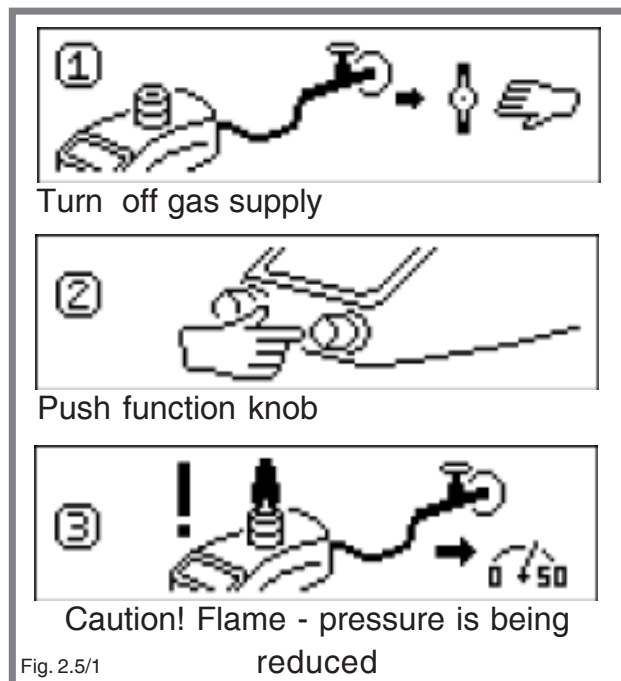

## 2.6 Internal charging function, battery symbol

If the unit is operated with rechargeable batteries independent of mains electricity, when the unit is switched on the battery symbol appears after several seconds instead of the menu arrows. The symbol appears to be “emptying” depending on the condition of the batteries. If the batteries are low the unit start to “beep” every 10 seconds („Beep-signal“ only if Buzzer is turned on, see paragraph 5.5). If the completely empty battery symbol begins to blink, there are only a few minutes use remaining before the unit switches off entirely. In order to continue operation independent of mains electricity, charge the batteries. Charging takes place independently of whether the device is on or off. Charging starts automatically depending on battery condition as soon as the power cable is plugged into the socket (9). While charging, a battery being filled is displayed. The unit can be used quite normally during the charging process.

**i** The batteries are charged only if the power cord of the included power supply is inserted directly into the socket (9). If the power supply is connected indirectly over a foot pedal (optional) so that the power cord is inserted in the socket of the foot switch, the batteries are not charged for technical reasons. Information about the optional use of an **external battery charger is available in paragraph 8.**

**!** **If the battery symbol does not appear when charging discharged batteries, the batteries could be exhaustive discharged. Extremely exhaustive discharged batteries cannot be charged. Use external charging station.**

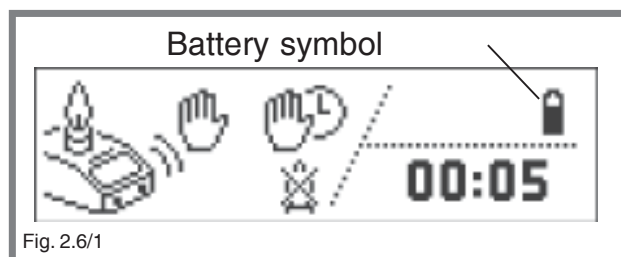

### 3. Application programs

This Section explains the different application programs and how to vary the burning times. Apart from the temperature monitoring, the symbols in the application programs are animated to simplify their use.

#### 3.1 Button Start-Stop

The flame is ignited by actuating the function knob **(1)**. To extinguish the flame actuate the function knob **(1)** once again. In addition the burner is automatically stopped if the burning time has expired.

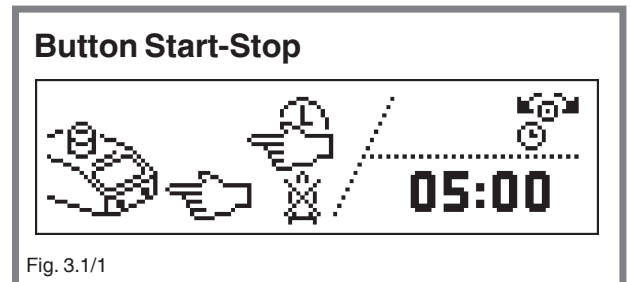

**(i)** To change from the Start-Stop Button application program to the next program, turn the function knob **(1)** to the right.

**Varying the burning time 1sec. - 2 h:** The burning time can only be set when the flame is off. To do this, turn the function knob in the application program to the left (see navigation arrows). The burning time blinks. The minutes can be varied by turning the function knob **(1)**. After setting the minutes, briefly push the function knob **(1)**. The seconds can now be varied by turning the function knob **(1)**. Once the desired time has been set, briefly push the function knob **(1)** to return to the application program. The burning time set has been memorized.

#### 3.2 Sensor Auto-Off

The flame is ignited by passing your hand over the IR sensor **(5)**. The flame extinguishes automatically after the burning time has expired. Alternatively the burner can be stopped by a short push on the function knob **(1)**.

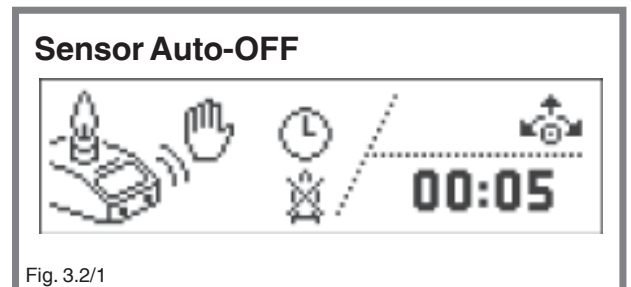

**!** If the DoubleClick function is switched off, the flame ignites IMMEDIATELY if the IR sensor is activated, i.e.: if a hand or an object is within the detection range!

**(i)** The status of the IR sensor is shown on the display. If the IR sensor perceives a hand or an object in the detection range, the “Sensor activated” symbol is displayed. If the DoubleClick function is switched on to activate the flame, **(see paragraph 5.2)** after the first sensor activation, the “2x” symbol appears for the duration of the DoubleClick time which has been set. During this time, pass your hand once again over the sensor in order to ignite the flame. The settings for the IR sensor (DoubleClick, DoubleClick time and detection range) can be set individually (see paragraph 5.2).

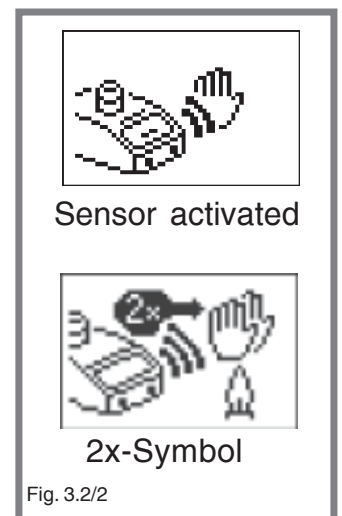



**Varying the burning time 1sec. - 2 h:** The burning time can only be set when the flame is off. To do this, briefly press the function knob **(1)** in the application program. The burning time blinks. The minutes can be varied by turning the function knob **(1)**. After setting the minutes, briefly push the function knob **(1)**. The seconds can now be varied by turning the function knob **(1)**. Once the desired time has been set, briefly press the function knob **(1)** to return to the application program. The burning time set has been memorized.

**!** When the burning time of the application program Sensor Auto-Off is set to 00:00, the flame is burning as long as a hand is present in the detection range of the IR sensor.

**i** As long as a hand or an object is present in the detection range of the IR sensor and the IR sensor is activated („Sensor activated“ symbol is displayed), it is not possible to switch over to setting the burning time.

To switch over from the application program Sensor Auto-Off to another program, turn the function knob **(1)** to the right or to the left.

### 3.3 Sensor Start - Stop

The flame is ignited by passing your hand over the IR sensor **(5)**. Passing your hand once again extinguishes the flame. In addition the burner is stopped automatically if the burning time has expired. Alternatively the burner can be stopped by a short push on the function knob **(1)**. **Varying the burning time 1 sec - 2 h: see paragraph 3.2 „Sensor Auto-Off“**

**!** If the DoubleClick function is switched off, the flame ignites IMMEDIATELY if the IR sensor is activated, i.e.: if a hand or an object is within the detection range!

**i** The status of the IR sensor is shown on the display. If the IR sensor perceives a hand or an object in the detection range, the “Sensor activated” symbol is displayed. If the DoubleClick function is switched on to activate the flame, **(see paragraph 5.2)** after the first sensor activation, the “2x” symbol appears for the duration of the DoubleClick time which has been set. During this time pass your hand once again over the sensor in order to ignite the flame. The settings for the IR sensor (DoubleClick, DoubleClick time and detection range) can be set individually **(see paragraph 5.2)**.

**i** As long as a hand or an object is present in the detection range of the IR sensor and the IR sensor is activated („Sensor activated“ symbol is displayed), it is not possible to switch over to setting the burning time.

To switch over from the application program Sensor Start - Stop to another program, turn the function knob **(1)** to the right or to the left.

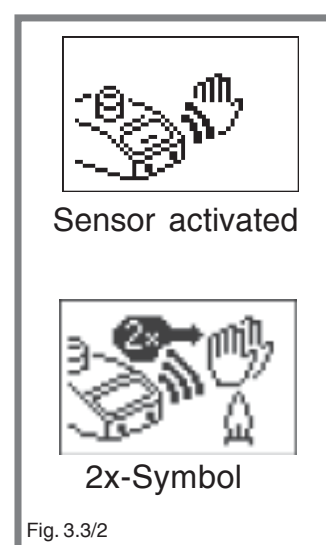
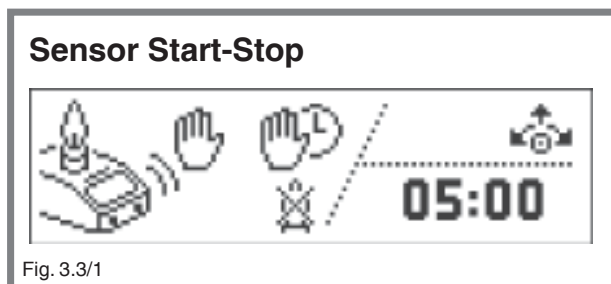



### 3.4 Pedal Standard

The flame is ignited by operation of the foot pedal. The foot pedal remains depressed for the duration of use. For the duration of use the burning time is shown on the display. The flame is extinguished upon release of the pedal. (In case of a connected Autoloop Pro the unit switches over to a special Autoloop program. Please see Autoloop Pro manual for further information.)

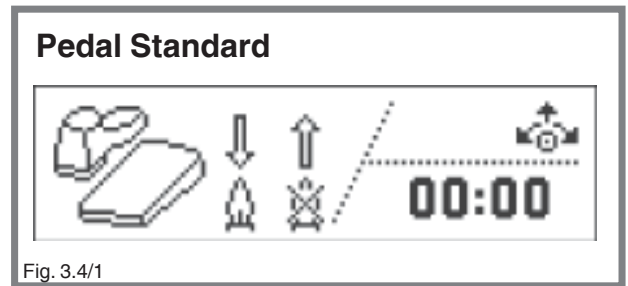

**i** This application program can only be used if the foot pedal is connected. To switch over from the application program Pedal Standard to another program, turn the function knob **(1)** to the right or to the left.

### 3.5 Pedal Start-Stop

The flame is ignited by operation of the foot pedal. The flame is extinguished after renewed actuation of the foot pedal. Additionally the flame is automatically extinguished when the burning time has expired. Alternatively the burner can be stopped by a short push on the function knob **(1)**. (In case of a connected Autoloop Pro the unit switches over to a special Autoloop program. Please see Autoloop Pro manual for further information.) **Varying the burning time 1 sec - 2 h: see paragraph 3.2 „Sensor Auto-Off“**

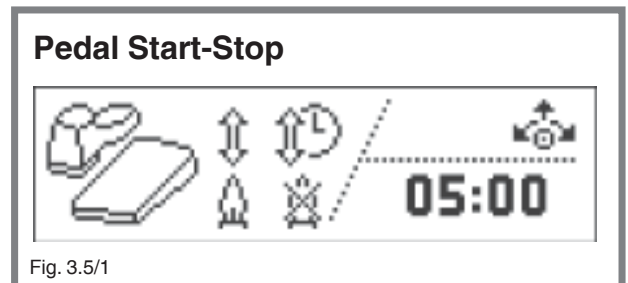

**i** This application program can only be used if the foot pedal is connected. To switch over from the application program Pedal Start - Stop to another program, turn the function knob **(1)** to the right or to the left.

### 3.6 Temperature regulation

This application program serves to maintain constant heating by temperature regulation. To use this application program a temperature sensor and measuring adapter must be connected to the foot pedal socket (Temperature sensor and measuring adapter optional accessory). After switching over to the application program, first the nominal temperature is adjusted by turning the function knob **(1)**. To memorize, press the function knob **(1)**. After that, how long the nominal temperature is to be maintained is adjusted with the timer. To confirm, press the function knob **(1)**.

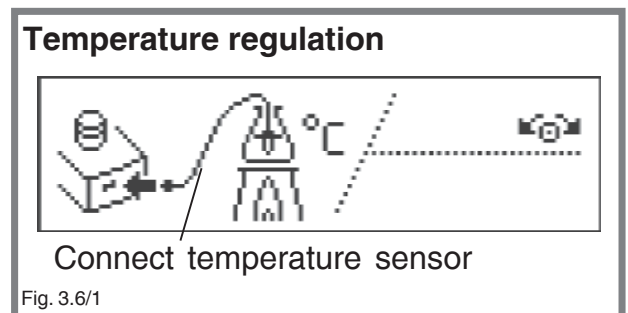

**i** During the temperature regulation program, the timer only starts to count down once the nominal temperature has been reached.

Finally the flame symbol blinks. If the function knob **(1)** is turned and the symbol „Flame on“ is selected and is confirmed by a press on the function knob, the temperature regulation program starts and heating begins.

**! THE FLAME IGNITES AUTOMATICALLY!**  
**Once the nominal temperature has been reached, the flame is extinguished. If the temperature drops below the nominal as a result of cooling, the FLAME IS AUTOMATICALLY REIGNITED!**

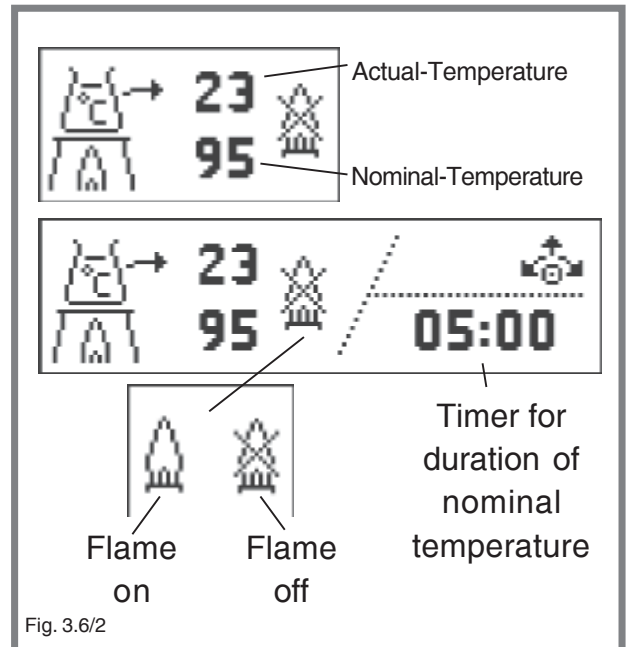

The temperature regulation program finishes when the nominal temperature has been reached and the timer period has expired.

**i** If the „Flame off“ symbol is selected and is confirmed by a push on the function knob **(1)**, the setting procedure comes to an end without the temperature regulation program being started. By turning the function knob **(1)**, the application program can now be exited; by pressing the function knob **(1)** the parameters for the temperature regulation program can be set again.

### 3.6.1 Safety stop for temperature regulation program

For safety reasons the temperature regulation program can switch off automatically if, with the flame lit, the temperature does not increase (or only increases very little). Furthermore, switching off takes place if the temperature drops during the adjustment procedure while the flame is activated. In this event the flame is extinguished and the ( $\Delta T / \Delta t$ ) symbol is displayed for 3 seconds.

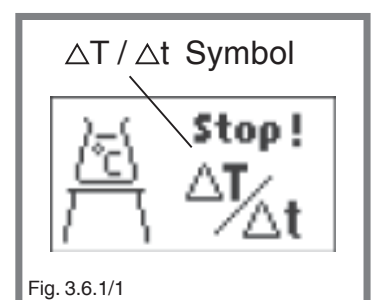

#### 4. Reminder function menu

The reminder functions simplify handling the safety laboratory gas burner.

##### 4.1 Cooling time reminder

The cooling time reminder is helpful to determine the exact cooling down time of e.g.: inoculation loops. In the background, this function counts down a pre-set cooling down time. Once the cooling down time has expired, a short acoustic signal sounds and a reminder symbol appears on the Display.

To set the cooling down time in the reminder functions menu, select the inoculation loop symbol and confirm by a push on the function knob **(1)**.

In the following menu item the cooling down time can be set between 1 and 25 seconds. If "-- sec" is selected, the function is deactivated and no reminder will be given (factory default setting: "-- sec"). Another push on the function knob **(1)** memorizes the time set and the menu item is exited.

 The acoustic signal can be deactivated in the settings menu (see paragraph 5.5).

##### 4.2 Gas consumption display

Using this function, a gas duration specific to one cartridge type can be set. In this case, during operation a cartridges symbol appears which empties according to the burn time. Once the time has expired, a reminder is given to notify the user to have a new cartridge at hand. The gas consumption display is **independent of the user accounts**. The settings apply to both user accounts.

 **This reminder is a INDICATION that the cartridge in use could be empty soon. This reminder is NOT A DEMAND to change the cartridge immediately!! Note in particular that gas cartridges without a built-in valve should only be changed if the gas cartridge is completely empty ! When changing the cartridge, ensure adequate ventilation.**

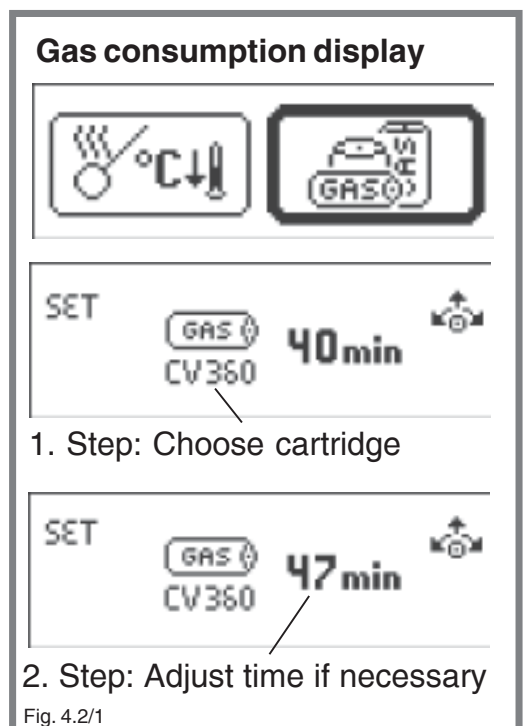
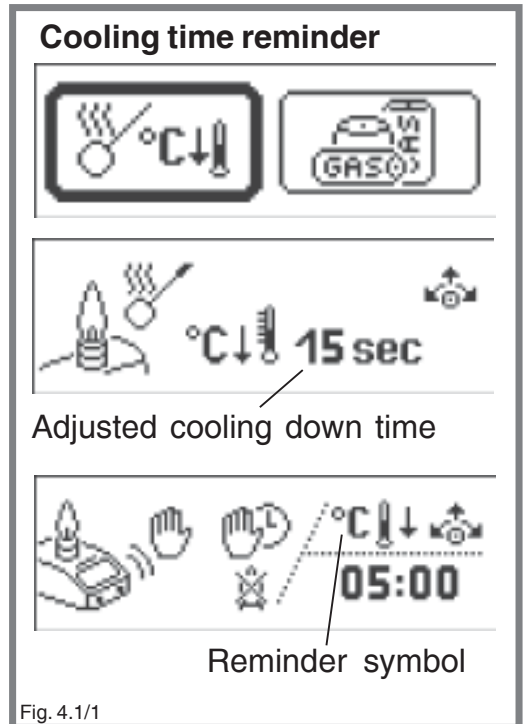
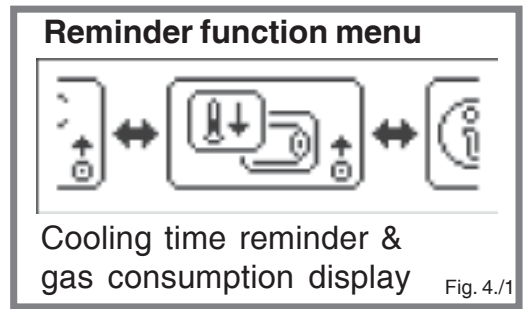

For setting the gas duration in the reminder functions menu select the gas cartridge symbol and confirm with a push on the function knob **(1)**. Now in the 1st step the kind of cartridge can be selected by turning the function knob **(1)**. Depending on the cartridge selected, previously specified times taken from a database appear on the Display.

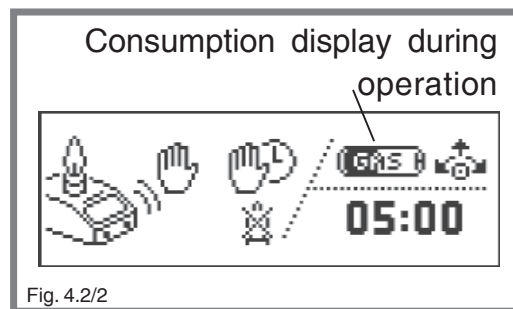

Fig. 4.2/2

Confirm the type of cartridge by pressing the function knob **(1)**. In the 2nd step the burning time can be individually adjusted to achieve even more precise timing if necessary. By pressing the function knob **(1)** the value set is memorized and the menu item is exited.

**i** The gas consumption display is deactivated if in the 1st step the “crossed out cartridge” symbol is selected (factory default setting).

**i** The burning time of the cartridge or the cartridge pressure depends on the temperature. Very low indoor temperatures give rise to a small flame if the device is used for long periods, since the pressure inside the cartridge drops. Overall this results an increase of the cartridge burning time.

#### 4.2.1 Reminder of gas consumption

If the adjusted cartridge burning time has expired, a reminder appears on the display at the same time as the opportunity is given to reset the burning time in order to adapt it to the real time remaining.

If necessary, change the burning time and confirm with a short push on the function knob **(1)**.

The cartridge burning time is now reset to the new value.

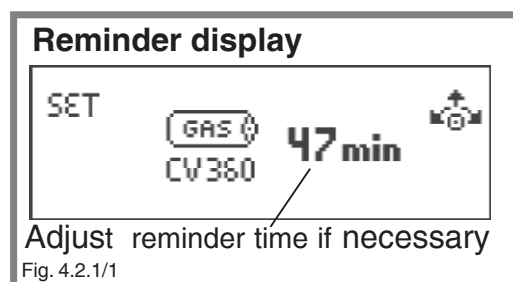

Fig. 4.2.1/1

**i** The reminder occurs only after the previously set cartridge burning time has expired **and** the next time the flame is extinguished, i.e.: current use of the burner is not interrupted by the reminder. This may lead to inaccurate times in the event of long burning times.

#### 4.2.2 Resetting the gas consumption display

The gas consumption display can also be reset if the cartridge burning time has still not expired completely. To do this, simply follow the steps for the gas consumption display function again. **(see paragraph 4.2)**

By confirming again the kind of cartridge and cartridge burning time, the cartridge burning time which has expired up to now is reset.

**i** If necessary, change the cartridge burning time to achieve higher accuracy.

## 5. Settings

The settings menu is intended to personalise extended functions and safety devices such as the DoubleClick IR sensor or Burner Head Control (BHC). The settings depend on the user and can be adjusted separately for both user accounts (see Section 2.2). To access the settings menu, select the settings symbol and confirm with a short push on the function knob **(1)**.

The wrench in the top right corner indicates that you are in the settings menu.

### 5.1 BHC, Burner Head Control

The BHC safety function indicates a clogged burner head (**see paragraph 6.2**) and in the event of clogging the maximum burning time is limited to 30 seconds.

**i** In the event that the BHC display is blinking (**see paragraph 6.2**), all burning times longer than 30 seconds are automatically reduced to 30 seconds. If the automatic burning time is reduced, a fault symbol is displayed after the burning operation. (**see paragraph 7.3**).

In order to switch the time limit on or off select the burner head symbol “BHC” by a push on the function knob **(1)** in the settings menu. In the submenu which appears, BHC can be switched on or off by turning the function knob **(1)**.

Burner Head Control BHC: ON  
30-second time limit activated  
(30s symbol not crossed out)  
**(factory default setting)**

Burner Head Control BHC: OFF  
30-second time limit deactivated  
(30s symbol crossed out)

### 5.2 IR-Sensor

In this menu item the DoubleClick settings and IR sensor range can be changed. To set, select the IR sensor symbol in the settings menu and confirm with a short push on the function knob **(1)**.

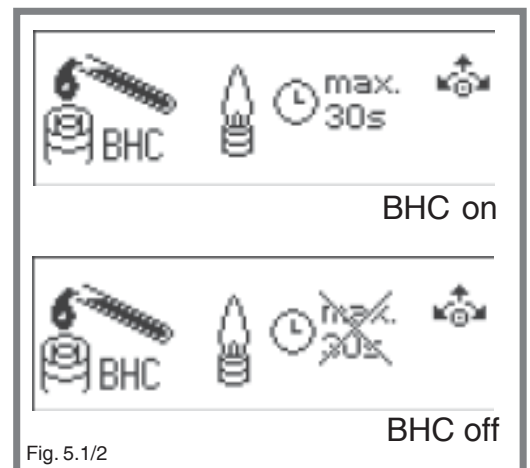
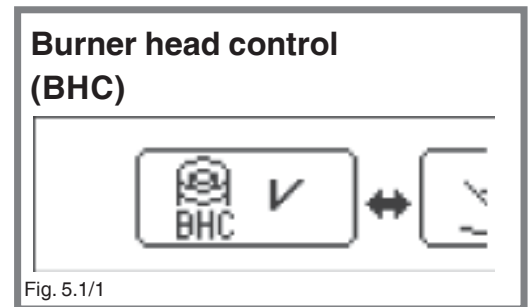
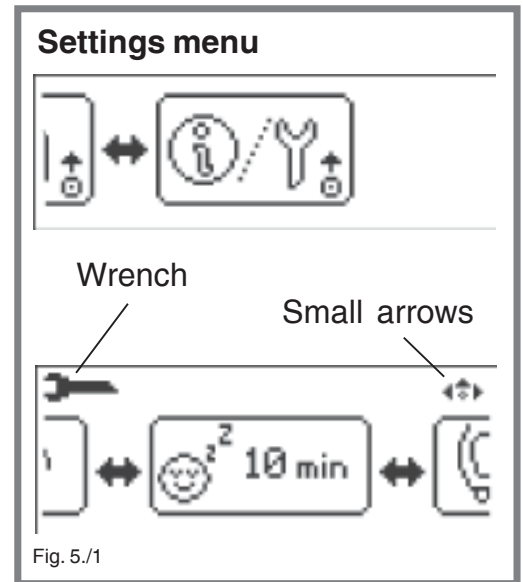

The first setting available allows the **DoubleClick function to be switched on and off**. With this additional, selectable safety function the burner ignites only after double activation of the DoubleClick IR sensor (5). Unintentional ignition of the flame is practically impossible.

- 1-hand symbol: **DoubleClick off**
- 2-hand symbol: **DoubleClick on (factory default setting)**

Select desired setting and confirm with a short push on the function knob (1) . If the “**DoubleClick off**” symbol is selected, the menu switches immediately over to the IR sensor range adjustment.

If the “**DoubleClick on**” symbol is selected, then the DoubleClick-time between 0.5 - 2.0 seconds can be selected. Confirm the setting with a short push on the function knob (1) and advance to the IR sensor range adjustment.

In this menu item, the **IR sensor range** (reaction distance) can be adjusted by turning the function knob (1) .

- Turning to the right: range increases
- Turning to the left: range decreases

The bar indicates the relative extent of the range.

**i** All IR sensor settings can be tested immediately while adjusting the setting by passing your hand over the IR sensor (5). When activated, the IR sensor symbol reacts accordingly. Keep changing the settings until the desired setting is reached.

If the “DoubleClick on” setting is selected, after the first sensor activation, the symbol “Pass 2X” appears. Only after the sensor has been activated a second time within the double-click time does the symbol “Sensor activation OK” appear. If the “DoubleClick off” setting is selected, as soon as the sensor is activated the first time, “Sensor activation OK” appears.

**!** It is possible to adjust the sensor range to 0 mm or more than 50 mm. Then the IR-Sensor is out of range and cannot be activated. In that case, increase or decrease the IR-Sensor range.



Fig. 5.2/1

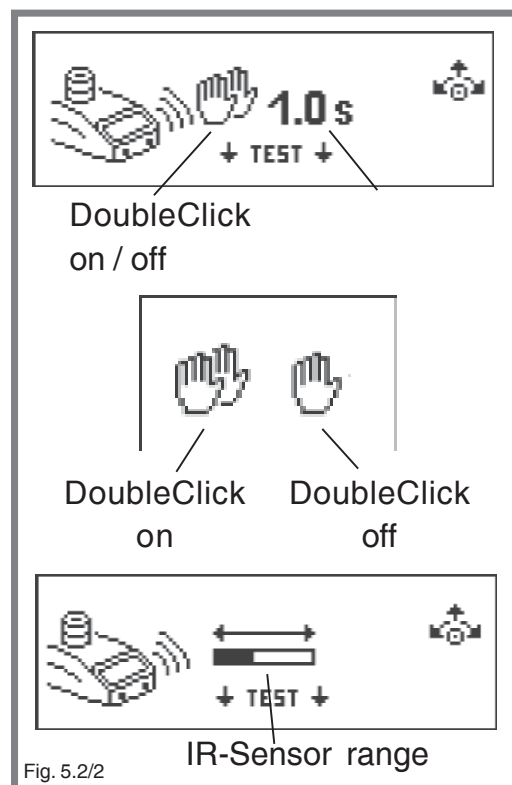

Fig. 5.2/2

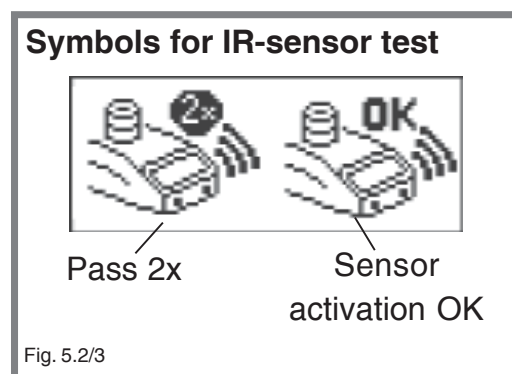

Fig. 5.2/3



### 5.3 Stand-by time

When the flame has not been ignited for a longer time as set on the stand-by-timer or the function knob (1) has not been actuated, the unit is switched off to avoid accidental activation, for example after a break. This safety function can be adjusted in the range from 1 - 120 minutes.

To set the stand-by time, select the appropriate symbol in the settings menu and confirm with a short push on the function knob (1). Change the stand-by time by turning the knob. Once the desired time is reached, push the function knob (1) once again to memorize the value and switch back to the settings menu. **(factory default setting: 10 min)**



Fig. 5.3/1

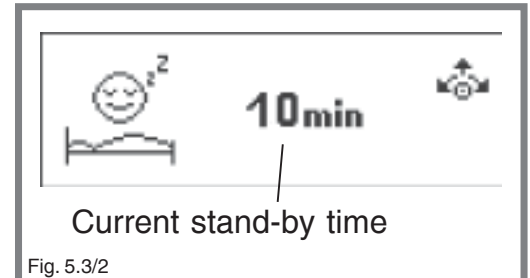

Fig. 5.3/2

### 5.4 Brightness / Contrast

This function allows the brightness and the contrast of the Display to be adjusted. To set the brightness / contrast, select the symbol in the settings menu and confirm with a short push on the function knob (1). In the 1st step the brightness (values: 1 - 30, **factory default setting: 30**) can be changed by turning the function knob (1). Memorize the value with a short push on the function knob (1). Next set the contrast (values 1 - 25, **factory default setting: 15**) and likewise memorize with a short press on the function knob (1).

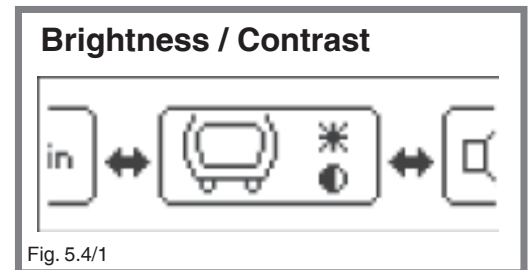

Fig. 5.4/1

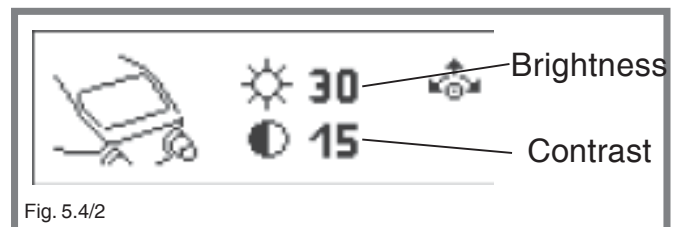

Fig. 5.4/2

### 5.5 Buzzer

This function allows to switch on and off the built-in buzzer. To set the buzzer, select the symbol in the settings menu and confirm with a short push on the function knob (1). By turning the function knob (1), switch the buzzer on or off. **(Factory default setting: on)** To memorize and exit the submenu, briefly push the function knob (1).



Fig. 5.5/1

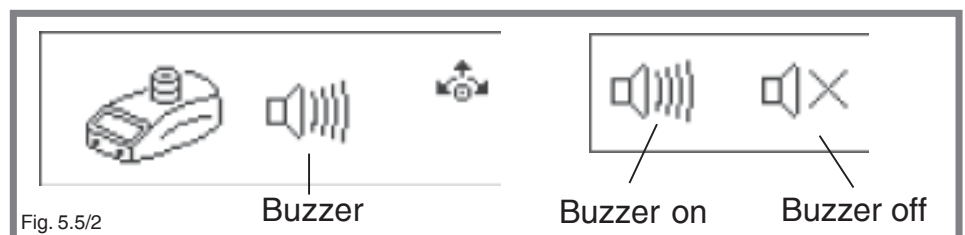
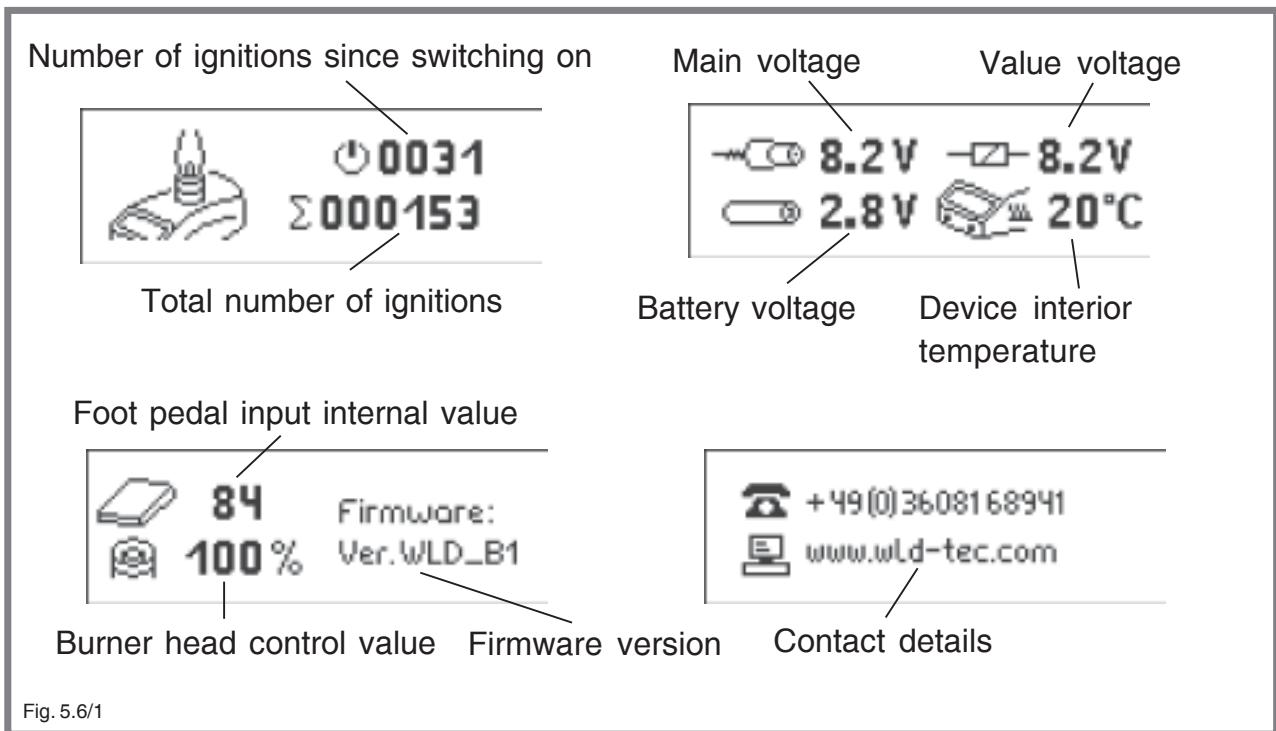

Fig. 5.5/2

## 5.6 Information menu

In the information menu a variety of system parameter settings can be accessed. In order to access, select the information menu symbol in the settings menu and confirm with a short push on the function knob **(1)**. In order to access the individual information sections, in each case briefly push the function knob **(1)**.



## 5.7 Factory default settings

In the factory default setting menu item, the unit can be reset to the factory default setting. Resetting affects all parameters, settings and burning times.

To reset the unit to the factory default settings, select the factory default settings in the settings menu and confirm with a short push on the function knob **(1)**. In the following menu item, select the “tick” (✓) and confirm with a short push on the function knob **(1)**. The unit restarts after a few seconds.

If the unit is NOT to be reset to the factory default settings, select the “cross” (X) symbol and confirm with a short push on the function knob **(1)**.

This also exits the factory default settings menu.

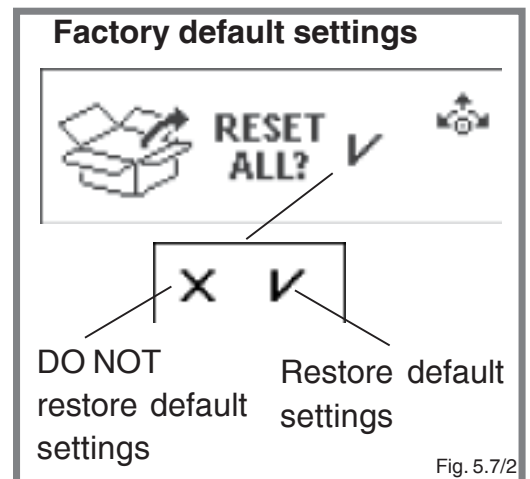
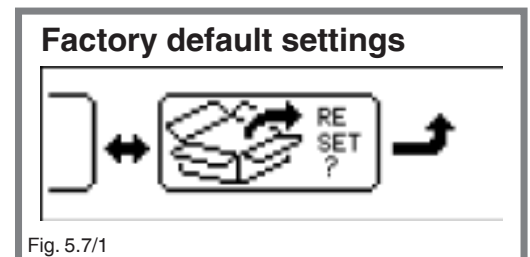



## 5.8 Exiting the settings menu

To exit the settings menu, turn the function knob to the right until you reach the return arrow. At this point the settings menu is automatically exited and the Display switches over to the main menu level.

### Exiting the settings menu



Fig. 5.8/1

Return arrow

## 6. Safety warning display

Safety warnings appear on the Display during operation and warn the user of possible dangers.

### 6.1 Residual heat display

After some time in use, the residual heat display lights up red and indicates a hot burner head. Even after switching-off the unit the residual heat display remains “on” until the burner head is cooled down.

**i** Disconnecting the power supply or removing the power cord will clear the residual heat display even if the burner head is still hot.



### 6.2 Burner head control (BHC, Burner Head Control)

If the burner head is clogged “BHC” will blink on the Display. Additionally, if BHC is ON in the settings menu, the maximum burning time will be limited to 30 seconds. **(see paragraph 5.1)**

If BHC is blinking it is requested to clean the burner head immediately. **(see paragraph 9.1)**

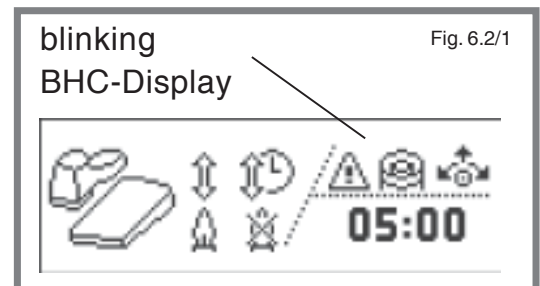

### 6.3 Battery monitoring

If the batteries are low the unit start to “beep” every 10 seconds („Beep-signal“ only if Buzzer is turned on, see paragraph 5.5). The totally empty battery symbol starts flashing as soon as the capacity of the rechargeable batteries is almost exhausted. The device can be operated only for a few minutes, after which it shuts down automatically. Charge the rechargeable batteries for further operation independently of the mains power supply **(see paragraph 2.6)** or replace them **(see paragraph 8)**.

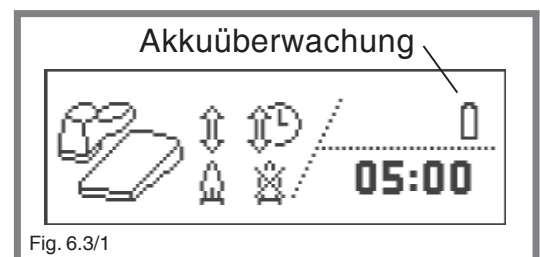

## 7. Error Display

If a malfunction occurs during operation, if necessary the gas supply will be shut off automatically and the appropriate error symbols will appear on the Display.

**i** All error displays can be reset by a long push (2 seconds+) on the function knob (1). (In case of overtemperature the unit needs to be cooled down and in case of burner head assembly monitor the burner head needs to be reinstalled prior a reset is possible.)

### 7.1 Ignition failure

These symbols appear if the flame fails to ignite after approx. 7 seconds or if the flame is extinguished during operation.

In case of ignition failure check the burner head (6) for possible clogging, check the correct input pressure of the gas supply and verify that the correct nozzle is installed.

Nozzle **N, 08**: Natural gas, 18-25 mbar

Nozzle **P, 06**: Propane / Butane gas, 47-57 mbar

In case of this malfunction the gas supply will be shut off automatically.

### 7.2 Overtemperature

This message indicates a malfunction if the interior temperature has exceeded 70 °C. At a normal room temperature with normal air circulation the unit is suited for continuous operation. In case of overtemperature increase the air ventilation or change the operation site.

In case of this malfunction the gas supply will be shut off automatically.

### 7.3 BHC - Time limit active

This message indicates that the time limit (30seconds) was turned on due to a clogged burner head. For cleaning the burner head see paragraph 6.2 & 9.1.

**i** In the event that the BHC display is blinking (see paragraph 6.2), all

#### Reset error display

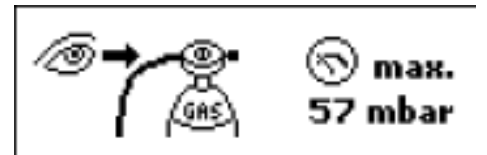

Fig. 7.1/1

#### Ignition failure



Check the burner head (6) for clogging



Check the gas pressure

Fig. 7.1/1

#### Overtemperature



Fig. 7.2/1

#### BHC Time limit



Fig. 7.3/1



Clean burner head (6)

Fig. 7.3/2



Check burner head (6) for clogging

burning times longer than 30 seconds are automatically reduced to 30 seconds. In the event of an automatic reduction in the burning time, the fault symbol is displayed after the burning operation.

To switch off the BHC time limit, **see paragraph 5.1.**

#### 7.4 Burner head assembly monitor

This message indicates that the burner head is removed. Further operation is possible after the burner head is reinstalled.

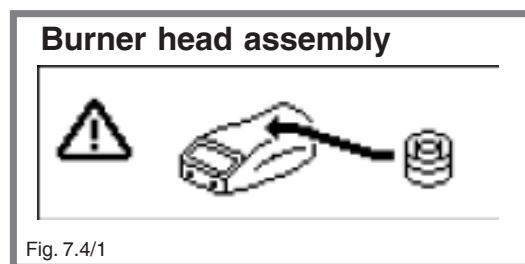

#### 7.5 Tilt sensor

If the burner is tilt for more than 90° (e.g. when changing rechargeable batteries), the burner deactivates itself automatically and the tilt sensor symbol is shown in the display for a couple of seconds.

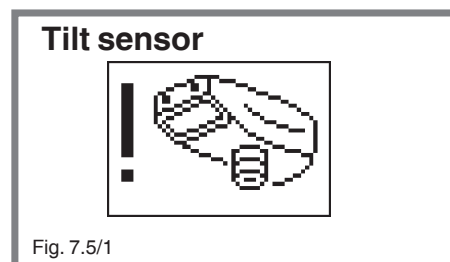

### 8. Battery replacement / using an external battery charger

**!** To replace the rechargeable batteries, switch off the device with the help of the function knob (1) and shut off the gas supply.

Open the battery compartment cover (20) in the direction of the arrow. Take the old batteries out and insert the new recharged batteries. **Please ensure correct polarity!** The polarity is illustrated in the battery compartments and on the battery compartment cover (The two plus poles of the rechargeable batteries are in the direction of the knobs). Close the battery compartment cover (20) again after replacing the rechargeable batteries.

The used standard Mignon rechargeable batteries can also be charged externally with the help of a WLD-TEC recommended charger (Product No.: 8.000.950).

Continuous operation is possible by using several externally charged battery sets. This way one can simply replace the empty batteries with the externally charged ones. In this case, the laboratory gas burner should not be connected to a power supply because the charging function is not required.

The external battery charger can be ordered under Product No.: 8.000.950.

Additional rechargeable batteries can be ordered under Product No.: 8.000.915.

For other recommended rechargeable battery types, please refer to Enclosure 2 / Page 33.

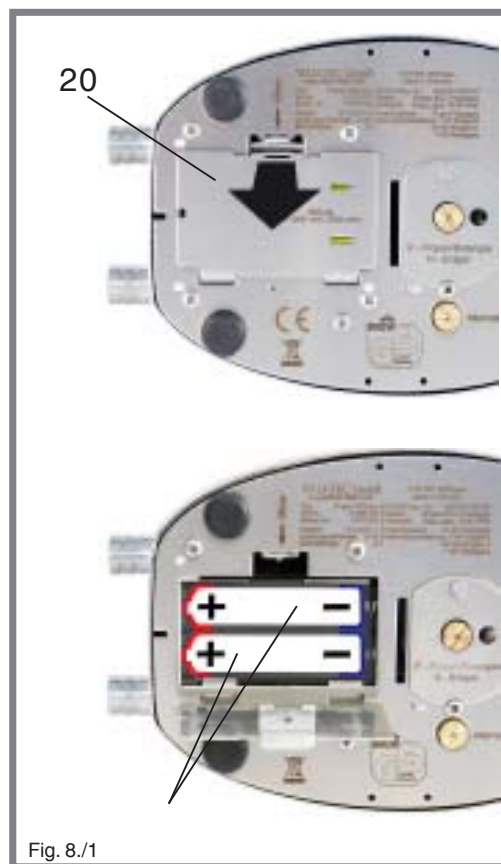

## 9. Cleaning and sterilizing

Allow sufficient time for burner orifice (6, 7) to cool down before disassembling or cleaning the burner head. Check the unit is disconnected and that the main gas supply is turned off. The burner can be cleaned with customary commercial disinfectants. Additionally, it is possible to remove the burner head and to clean it separately.

The stainless steel and glass construction allow 100% UV-radiation sterilization and short time surface flame sterilization.

 Because of the connectors at the back of the unit the backside should not be sterilized with a flame.

### 9.1 Burner head disassembly and cleaning

Allow sufficient time for burner orifice (6, 7) to cool down before disassembling or cleaning the burner head. Check the unit is turned off and check the main gas supply is turned off too. Clean the burner head with customary commercial disinfectants, sterilize it in an autoclave or wash in a dishwasher. To remove the burner head proceed as follows: Unscrew the burner head screw (12)

completely with the included screwdriver (R3).

Turn approx. 8 revolutions to the left. Now remove the burner head from the device by pulling it upwards.

Reinstallation is performed in the reverse sequence.

The dismantled burner head can be even dismantled into the individual components for in-depth cleaning: Unscrew both screws (12a) with the included screwdriver (R3) and take off the base plate (12b) of the burner head which was fixed by the two screws (12a). After the base plate is removed both electrodes (13, 14) can be pulled out for separate cleaning. Reinstallation is performed in the reverse sequence.

 When dismantling the burner head completely the sealing ring placed around the burner head screw (12) could dropout. Ensure that the sealing ring is placed around the burner head screw (12) when reassembling..

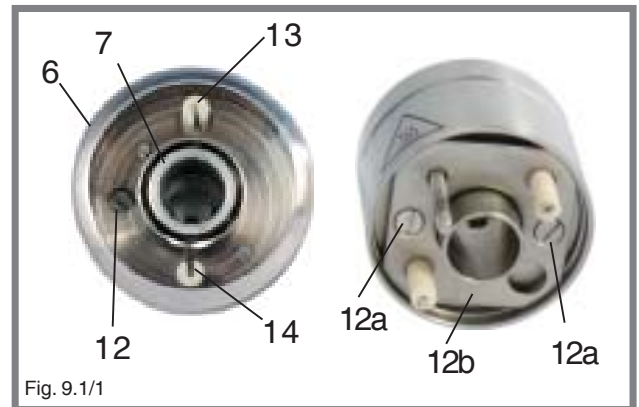

### 9.2 Burner shaft cleaning

Unscrew the screw (18) completely at the bottom of the unit with the included screwdriver (R3) Take off the cover (17) of the burner shaft. Now the burner shaft can be cleaned or solid substances which have fallen into the unit can be removed. Reinstallation is performed in the reverse sequence. Take care that the notch of the cover fits to the screw (18a). Screw in the screw (18) completely with the screwdriver (R3)

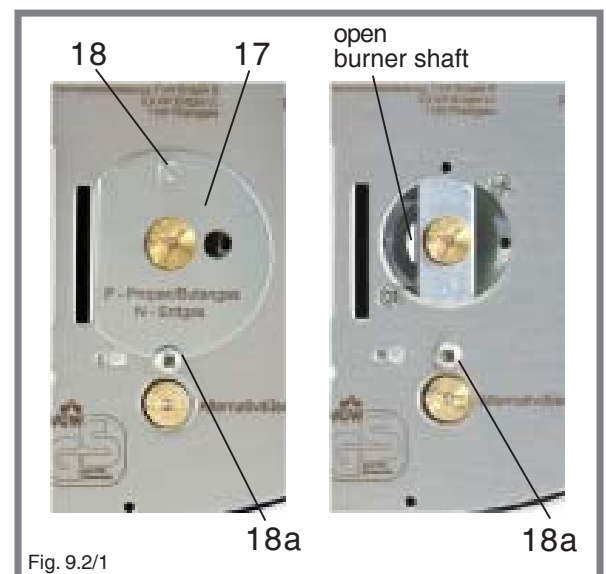

## 10. Turbo flame

If the cover of the burner shaft (17) is removed the flame is extremely firm and consistent. To take off the cover of the burner shaft (17) unscrew the screw (18) completely at the bottom of the unit with the included screwdriver (R3). With an open burner shaft the intensity of the flame cannot be adjusted by the air knob (2) any longer. During the use of the turbo flame most of the needed air is taken inside through the open burner shaft. Remounting the cover of burner shaft. (see paragraph 9.2)

## 11. Tilt adjustment

Insert the included tilt adjustment (R1) into the slots (19) at the bottom of the unit. The tilt-adjustment can be used to the left or right side to protect the burning chamber from contamination when working with liquids.

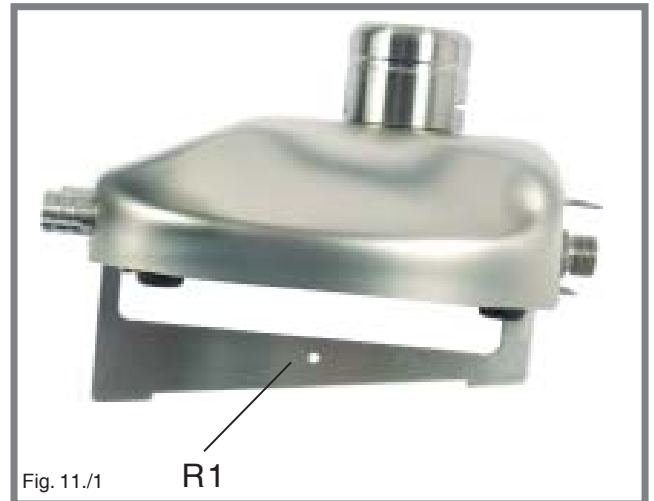

## 12. Warranty

The unit is covered under our two-year manufacturer warranty against any manufacture defects in material and workmanship. The WLD-TEC warranty guarantees all Fuegos under normal usage conditions and does not cover any damages as a direct result of user misuse or/and abuse. The warranty is void upon any unauthorized servicing, disassembly or modifications. In respect of parts to wear and tear (e.g. rechargeable batteries) this warranty shall be valid for six months from the date of purchase.

## Technical data

Technology Microprocessor, illuminated graphic display

### Programs

Button: Start-Stop with timer, 1 sec - 2 h

IR Sensor: Start-Stop with timer, 1 sec - 2 h

Auto-Off with timer, 0 sec - 2 h

Foot pedal: Standard (flame during pressed foot pedal)

Start-Stop with timer, 1 sec - 2 h

Temperature regulation: with timer, 1 sec - 2 h,

Temperature range, max. 35°C - 350°C

### Safety features

Safety Control System (SCS)

with gas safety cut off:

ignition and flame control, temperature monitor

burner head clogging monitor (BHC)

burner head assembly monitor, tilt sensor (>90°)

1 - 120 min

Automatic unit switch off:

Residual heat display: indicates a hot burner head

Zero-Pressure switch-off:

procedure to release the pressure of the supply hose

### Comfort functions

Cooling time reminder

Gas cartridge consumption display

### Gas supply and consumption

Gas supply:

1/4" left + filter

Gas types:

natural gas E/LL, 18 - 25 mbar / liquid gas II2ELL3B/P, 20 - 50 mbar

Connected load:

70 g/h liquid gas

Continuous cartridge operation

CV 360 - 40 min, Express 444 - 50 min,

CG 1750 - 150 min, C 206 - 170 min,

CP 250 - 210 min, CV 470 - 3470min

### Temperatures

Flame temperature:

1350 °C on liquid gas / 1300 °C on natural gas (E)

Temperature threshold level:

1 kW liquid gas, 1 kW natural gas

### Electrical

Power consumption:

2 VA

Power connection:

100 - 240 V / 50/60 Hz / max. 0.3 A / 9 V DC / 1 A

Rechargeable battery:

NiMH 2.4V (2 x Mignon (AA)) rechargeable Battery, 1.2V (2600mAh)

Hours of operation:

up to 9 hours of continuous start / stop operation  
(up to 2000 inoculation loop annealing operations)

Charging time:

90% full in 3 hours

Charging current:

700 mA

IR-Sensor coverage:

5 - 50 mm, adjustable

DoubleClick IR-Sensor:

time range 0.5 - 2.5 sec (can be adjusted or disconnected)

### Mechanical

Casing and operating controls:

stainless steel / glass, UV and solvent resistant

Burner head:

removable and decomposable, stainless steel

Cover of the burner shaft:

Ø 23 mm, with drains

Measurements (B x H x T):

103 x 49 x 130 mm

Weight:

700 g (without rechargeable batteries)

### Licences

DIN-DVGW Reg.-No.:

NG-2211AS0167

CE:

EN 61326-1, EN 61010-1

EEC guidelines:

2004/108/EC and 2006/95EC



## Enclosure 1: Installation and Operating Instructions

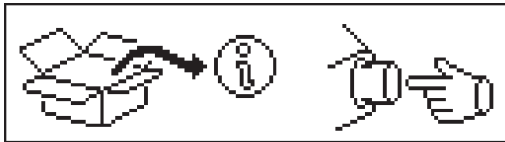

- Move forward through the installation instructions by pushing the function knob (1).



- Observe the operating instructions carefully!



- Use correct nozzle!



- For natural gas use nozzle N, 08!



- For propane / butane gas use nozzle P, 06!

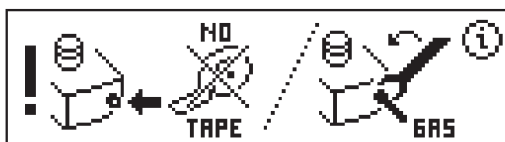

- Tighten all gas connections (left-hand thread) with a wrench.
- Do **NOT** seal the gas connection on the burner with Teflon tape or similar.

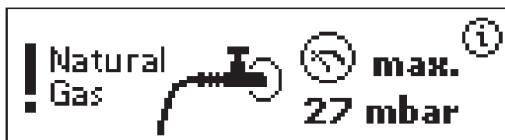

- Maximum inlet pressure natural gas:

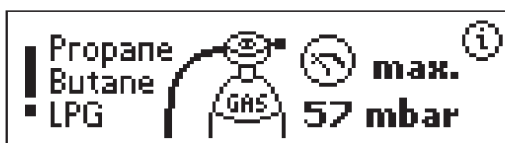

- Maximum inlet pressure propane / butane gas: 57 mbar



- To open gas supply: turn knob counter-clockwise
- To open air intake: pull knob outwards and turn counterclockwise



- General burner operations by pushing & turning.
- Switching on & off /resetting by long push



## Enclosure 2: Recommended rechargeable batteries

Technology: Nickel Metal Hydride (NiMH)

Size: AA (Mignon)

Standards: ICE: HR6, ANSI:1.2H2, Other: NH15

Voltage: 1.2 V

Capacity: 2300 – 2800 mAh

We recommend the following rechargeable battery types, because only these rechargeable batteries guarantee the specified number of operating hours, full functionality and long life:

- Panasonic 2600 mAh (Model: HHR-260AAB)
- Sanyo Superlative Alloy EVO 2700mAh (Model: HR-3U 1,2V)
- Energizer Rechargeable 2450mAh

The device is delivered with two approved rechargeable batteries.

Spare rechargeable batteries can also be ordered directly from WLD-TEC

(Product No.: 8.000.915).

## Enclosure 3: Battery Disposal

The **package** may contain **batteries**. They should **not be discarded with your regular household waste**. Under the “German Regulation Regarding the Taking Back and Disposal of Used Batteries” (German Battery Regulation – Batterieverordnung), we as the merchant are required to inform consumers that used batteries can be returned at locations such as **public collection points** or any **store** where batteries are sold.

Of course, you can also **return** used batteries that you have acquired from us free of charge:

### WLD-TEC

Halle-Kassler-Straße 49

D-37318 Arenshausen

Germany



Batteries that contain toxins are marked with this sign and a chemical symbol:

- Pb = battery contains lead
- Cd = battery contains cadmium
- Hg = battery contains mercury
- Li = battery contains lithium
- Ni = battery contains nickel
- Mh = battery contains metal hydride
- Zi = battery contains zinc



## EG-KONFORMITÄTSERKLÄRUNG

Declaration of Conformity

**zu den Richtlinien 2004/108/EG und 2006/95/EG(EEC)**

Following the Directives 2004/108/EC and 2006/95/EC (EEC)

**Der elektronische Laborgasbrenner der Serie:**

Electronic Laboratory gas burner

Fuego SCS pro Typ / type 8.204.000

**erfüllt die in den nachfolgenden Prüfgrundlagen aufgeführten Anforderungen in Verbindung mit den in Anhang A2 aufgeführten Netzgeräten.**

This declaration relates is in conformity with the relevant provisions of the following standards together with the normative document A2 mains connection.

1. **Elektromagnetische Verträglichkeit**  
Electromagnetic Compatibility Directive
  - 1.1 **EN 61326-1: 2006** **Elektrische Betriebsmittel für Leittechnik und Laboreinsatz, EMV-Anforderungen**  
EN 61326-1: 2006 Electrical equipment for measurement, control and laboratory use, EMC requirements  
**Störaussendung:** **Elektrische Betriebsmittel der Klasse B, Gruppe 1**  
Generic Emission Standard: Electrical Equipment, class B, Group 1  
**Störfestigkeit:** **Industrielle Bereiche**  
Generic Immunity Standard: Industrial areas
2. **Sicherheit elektrischer Betriebsmittel**  
Security of electrical resources  
**EN 61010-1:2001 Sicherheitsanforderungen an elektrische Meß-, Steuer-, Regel- und Laborgeräte. Teil1: Allgemeine Anforderungen**  
EN 61010-1: 2001 Safety requirements for electrical equipment for measurement, control, and laboratory use. Part 1: General requirements

B. Wartewig  
Geschäftsführer  
Manufacturer

Göttingen den 01.10.2011

## Trouble shooting guide

### The blue power lamp does not light up

Check for correct connection and specification of the power adapter.  
Ensure that the original power adapter is used.

Specifications: 9 V / DC, 1A

Polarity: + —  — -

### The foot pedal does not work

Check for correct connection of the foot pedal.  
Ensure that the foot pedal socket and plug is not twisted or broken.

### No Flame

In case of ignition or flame failure check if the burner head is clogged. Verify the input pressure of the gas used. Ensure that the correct nozzle is installed in the unit. **(see paragraph 7.1)**

Nozzle **N, 08**: natural gas, input pressure: 18-25 mbar

Nozzle **P,06**: propane / butane gas, input pressure: 47-57 mbar

### Inspection of the burner head (clogging)

Take care that there are no liquids or other substances at the Bypass (area between the inner and the outer ring). Contaminants can be removed, for example, with a brush.  
If there are contaminants in the area of the electrodes, the flame cannot encircle the electrodes correctly. For this reason pay particular attention to clogging in the areas marked in light colour and remove.  
The burner head can be cleaned with customary commercial disinfectants, or it can be sterilized in an autoclave or washed in a dishwasher.



### Flame burns 30 seconds, only

BHC time limit is active, BHC appears at the LCD. The burner head is clogged and must be cleaned **(see paragraph 9.1)**.

The time limit can be disconnected in the settings menu at point BHC **(see paragraph 5.1)**

### Flame too small / large / soft

Check the position of the air and gas adjustment.  
Check if the correct nozzle is installed.

Nozzle **N, 08**: natural gas, 18-25 mbar

Nozzle **P, 06**: propane / butane gas, 47-57 mbar

Check if the drilling of the active nozzle is blocked. Unscrew the active nozzle. **(see paragraph 1.1)** If the drilling is blocked clean with a brush or compressed air.

**No ignition spark / BHC blinks but the burner head is clean**

Remove the burner head and check if the ceramic electrodes are in good condition. In some cases the electrodes may break. Move the ends of the electrodes to check. If they are not moving they should be okay. If they are moving more than 0.5 mm the electrodes are broken. The electrodes can be dismantled and changed by the user. (see paragraph 9.1)

**The IR sensor does not react**

It is possible to adjust the sensor range to 0 mm or more than 50 mm. Then the IR-Sensor is out of range and cannot be activated. In the event that too large a range is set, in the "Sensor Auto-Off" and "Sensor Start-Stop" application programs, the "Sensor activated" symbol is permanently displayed.

Increase or decrease the range accordingly in the menu settings under "IR sensor"

(see paragraph 5.2).

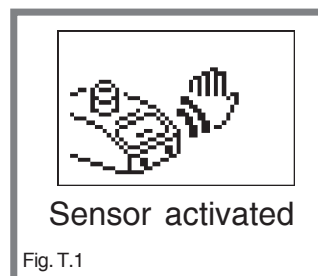
**The temperature regulation program switches off prematurely**

Safety stop is active due to too large or too small  $\Delta T / \Delta t$  (see paragraph 3.6.1)

**The unit switches off regularly because of overtemperature**

Increase the air ventilation or install the unit at a better ventilated operation site.

**Service address:**

WLD-TEC GmbH  
Produktion & Service  
Halle-Kasseler-Str.49  
37318 Arenshausen

Phone: 036081 68940  
Fax: 036081 68942

Email: sales@wld-tec.com  
Internet: www.wld-tec.com

## Notes

## Structure of menu

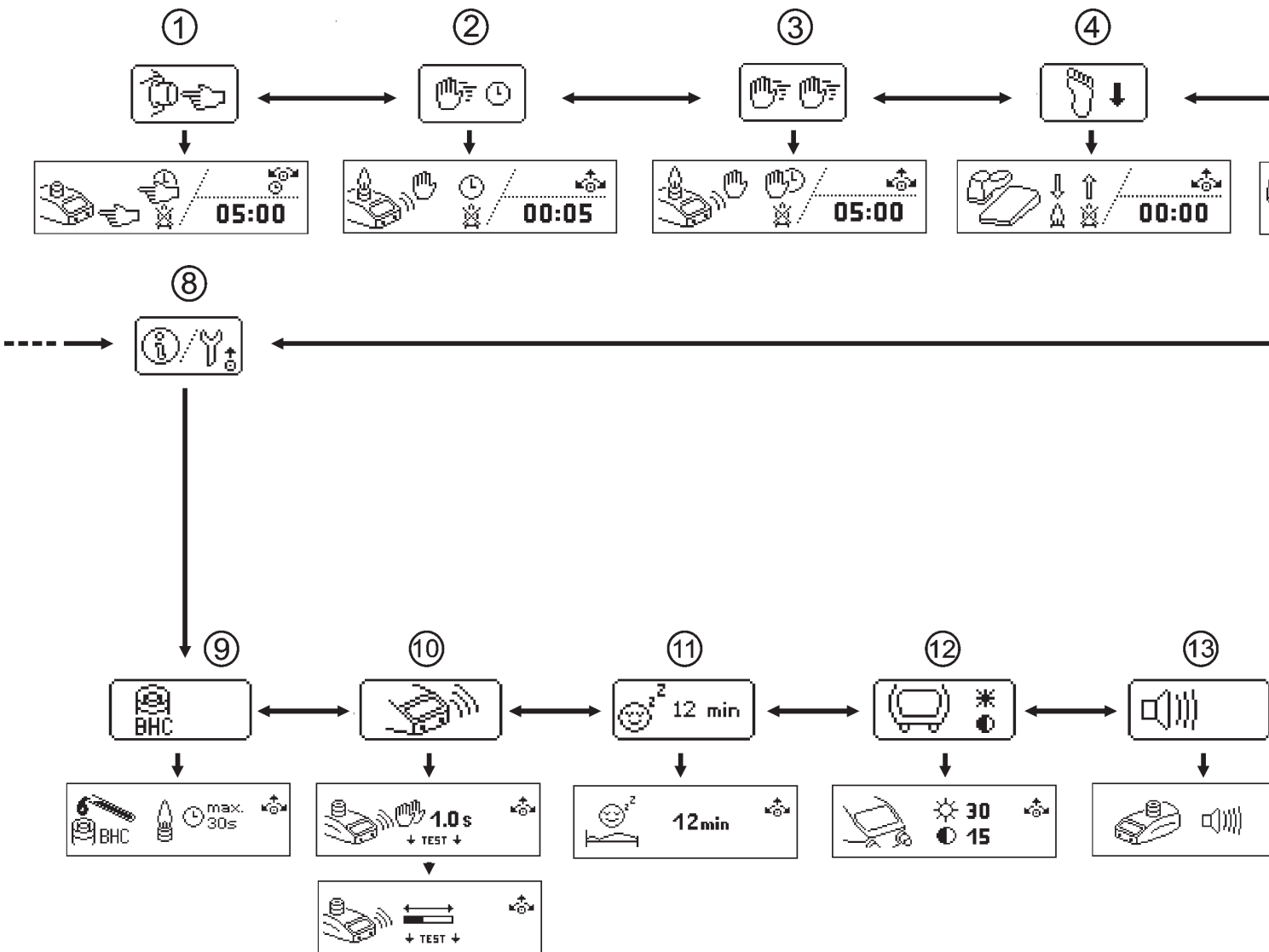

### Main menu level:

- 1 - Application prog. Button Start - Stop
- 2 - Application prog. Sensor Auto - Off
- 3 - Application prog. Sensor Start - Stop
- 4 - Application prog. Pedal Standard
- 5 - Application prog. Pedal Start - Stop
- 6 - Operation mode: Temperature regulation program
- 7 - Reminder function menu
- 8 - Settings menu

### Settings menu level:

- 9 - Burner Head Control (BHC)
- 10 - IR - Sensor settings
- 11 - Stand-by
- 12 - Brightness / Contrast
- 13 - Buzzer on / off
- 14 - Basic unit data
- 15 - Factory default settings

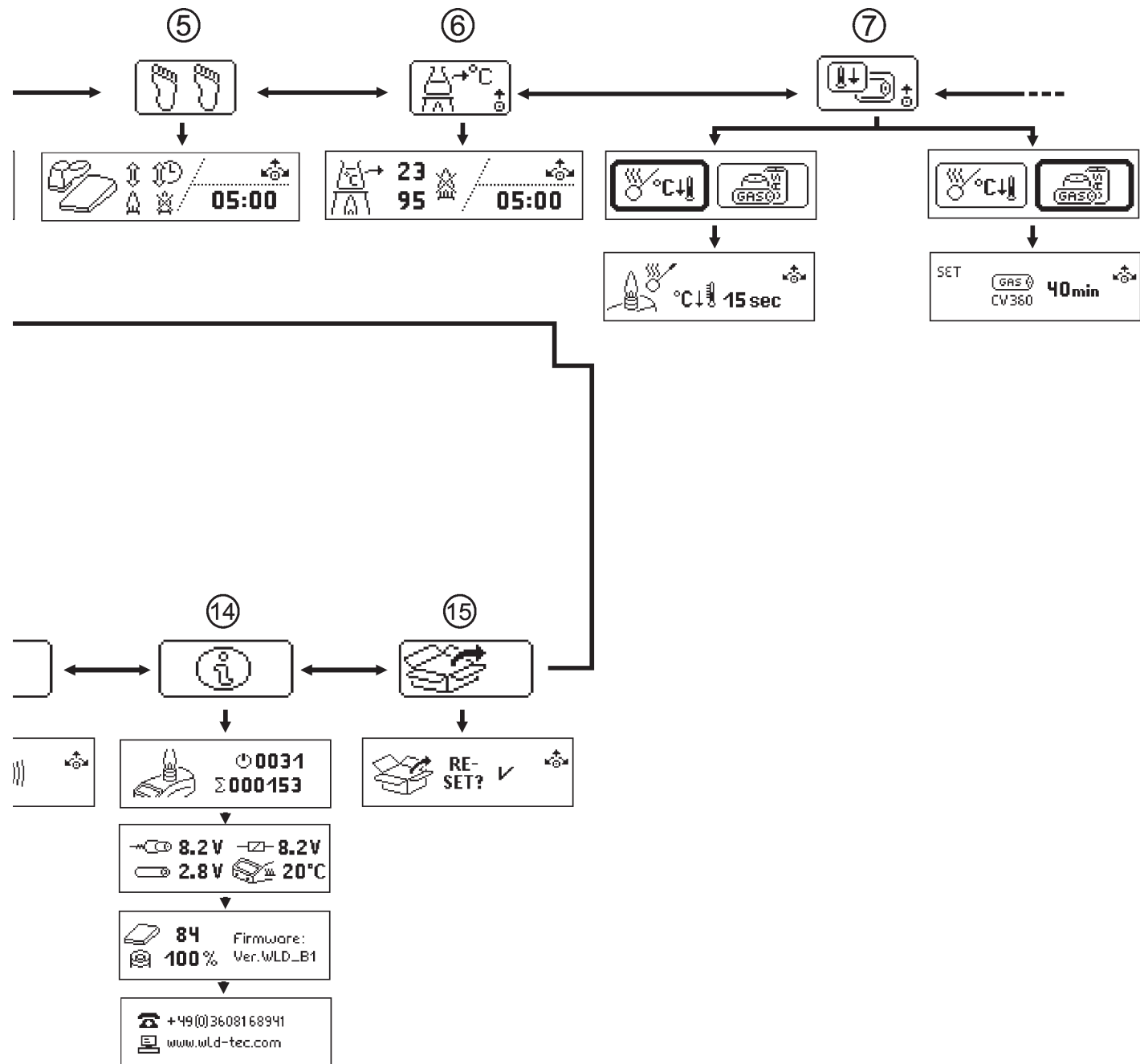

## WLD - TEC GmbH

**Sales Department:**  
Spandauer Weg 1  
D - 37085 Göttingen  
Phone: +49 (0)551/793789  
Fax: +49 (0)551/793707

**Production and Service:**  
Halle-Kasseler Straße 49  
D - 37318 Arenshausen  
Phone: +49 (0)36081/68940  
Fax: +49 (0)36081/68942

Internet: <http://www.wld-tec.com>

Email: [sales@wld-tec.com](mailto:sales@wld-tec.com)