



GUARDIAN™ 5000

Hotplate Stirrers



Reliable Hotplate Stirrers with Exceptional Safety Features for Everyday Use

OHAUS Guardian 5000™ Hotplates Stirrers are designed for safety and simplicity in all research, academia and industrial applications. The design ensures proper mixing and temperature control of the top plate or your sample when using the optional temperature probe. Heating models include a Single Point Calibration feature for multiple setpoints. Select from five models with three plate sizes for your everyday heating and stirring applications.

Unique Features:

- **SafetyHeat™ System Protects the Lab**

An industry-leading early detection system that uses two independent safety controls to continuously monitor the electronics and shut off heating before an overtemperature condition occurs.

- **Powerful, Consistent Stirring Performance**

Precise stirring from 60 to 1600 rpm is made possible by the design of a powerful motor, strong magnet and software controlled ramp rate, ensuring secure magnetic coupling for viscous applications.

- **Easy to Read LCD Display With Everything You Need to Know**

The bright LCD display includes large temperature and speed settings, intuitive icons and a prominent hot top indicator - all designed to quickly and easily monitor performance from across the lab.

- **Designed for Durability and Reliability with the Exclusive SmartHousing™**

The SmartHousing™ is chemical resistant with an innovative, easy-to-clean design that channels spills away from internal components and the angled control panel.

GUARDIAN™ 5000 Hotplate Stirrers

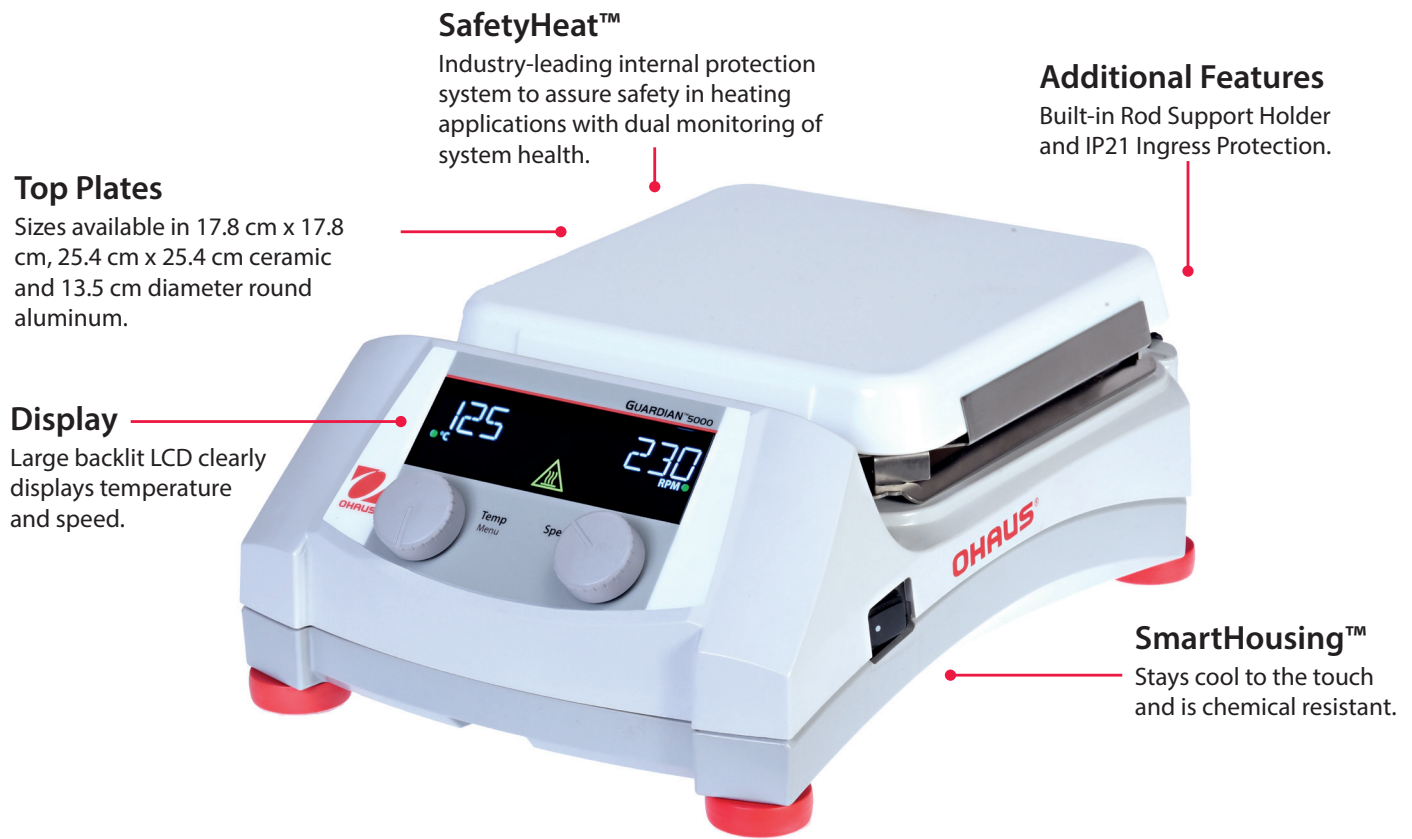

Model	e-G51ST07C	e-G51HP07C	e-G51HS07C	e-G51HS10C	e-G51HSRDM
Function	Stirring	Heating	Heating and Stirring		
Top Plate Size	17.8 x 17.8 cm			25.4 x 25.4 cm	13.5 cm diameter
Speed Range	60 rpm to 1600 rpm	--	60 rpm to 1600 rpm		
Speed Stability	+/-2 %	--	+/-2 %		
Temperature Range	--	Ambient + 5 °C – 500 °C			Ambient + 5 °C – 380 °C
Temperature Stability*	--	+/-3 % Plate, below 100 °C +/-2 °C and +/-1 % Probe, below 100 °C +/-1 °C			
Temperature Calibration	--	3 Plate and 3 Probe			
Control	Digital				
Display	Backlit LCD for Speed	Backlit LCD for Temperature	Backlit LCD for Temperature and Speed		
Capacity	15 L			18 L	20 L
Top Plate Material	Ceramic				Aluminum
Dimensions (H x L x W)	12.2 x 30.9 x 22.3 cm			12.2 x 41.5 x 28.6 cm	12.6 x 26.7 x 17.3 cm
Net Weight	2.6 kg			5.2 kg	2.6 kg
Power	230V, 0.5A, 50/60Hz	230V, 6.0A, 50/60Hz	230V, 7A, 50/60Hz	230V, 7A, 50/60Hz	230V, 4.6A, 50/60Hz
Power Consumption	104 W (230V)	1242 W (230V)	1449 W (230V)	1449 W (230V)	952 W (230V)
Working Environment	5 °C – 40 °C, 80 % RH, non-condensing				

* Conditions permitting. Variations in temperature measurement process, vessel, ambient and sample will impact actual performance.

GUARDIAN™ 5000 Hotplate Stirrers

Accessories

Item No.	Description	e-G51ST07C	e-G51HP07C	e-G51HS07C	e-G51HS10C	e-G51HSRDM
30500570	Base Plate, 135 mm					●
30500571	Handles for Base Plate					●
30500572	Sectional Block, 12 mm Vials					●
30500573	Sectional Block, 15 mm Vials					●
30500574	Sectional Block, 17 mm Vials					●
30500575	Sectional Block, 21 mm Vials					●
30500576	Sectional Block, 28 mm Vials					●
30500577	Sectional Block, 12 mm Test Tubes					●
30500578	Sectional Block, 16 mm Test Tubes					●
30500579	Sectional Block, 20 mm Test Tubes					●
30500580	Sectional Block, 25 mm Test Tubes					●
30500581	Uni Block, 12 mm Vials					●
30500582	Uni Block, 15 mm Vials					●
30500583	Uni Block, 17 mm Vials					●
30500584	Uni Block, 21 mm Vials					●
30500585	Uni Block, 28 mm Vials					●
30500586	Uni Block, 12 mm Test Tubes					●
30500587	Uni Block, 16 mm Test Tubes					●
30500588	Uni Block, 20 mm Test Tubes					●
30500589	Uni Block, 25 mm Test Tubes					●
30392233	Clamp, Specialty, Rod, CLS-RODS					●
30500590	Temperature Probe, 20 cm S/S		●	●	●	●
30500591	Temperature Probe, 20 cm PTFE		●	●	●	●
30500592	Temperature Probe, 25 cm S/S		●	●	●	●
30500593	Temperature Probe, 25 cm PTFE		●	●	●	●
30500594	In Use Cover Guardian, 17.8 cm x 17.8 cm	●	●	●		
30500595	In Use Cover Guardian, 25.4 cm x 25.4 cm				●	
30500596	In Use Cover Guardian, Round					●
30500597	Vessel Clamp	●	●	●	●	●
30500598	Stir Bar Retriever	●		●	●	●
30392314	Clamp, Specialty, Column, CLS-COLMNSS	●	●	●	●	●
30392315	Clamp, Specialty, Column, CLS-COLMNSM	●	●	●	●	●
30392316	Clamp, Specialty, Column, CLS-COLMNSL	●	●	●	●	●
30392317	Clamp, Specialty, Column, CLS-COLMNSX	●	●	●	●	●
30392318	Clamp, Specialty, Nester, CLS-NESTXS	●	●	●	●	●
30400145	Ultra Flex Support Kit	●	●	●	●	●
30400146	Support Rod And Clamp Kit	●	●	●	●	●
30400147	Spinbar, 2.5 cm PTFE	●		●	●	●
30400148	Spinbar, 3.8 cm PTFE	●		●	●	●
30400149	Spinbar, 7 cm PTFE	●		●	●	●
30400150	Spinbar, 10 cm with Pivot Ring PTFE	●		●	●	●

GUARDIAN™ 5000 Hotplate Stirrers

Outline Dimensions

e-G51ST07C, e-G51HP07C and e-G51HS07C

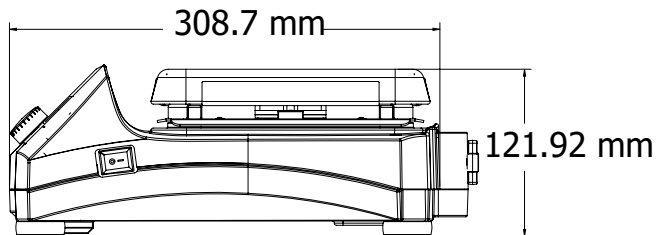
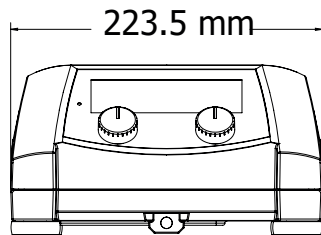

e-G51HS10C

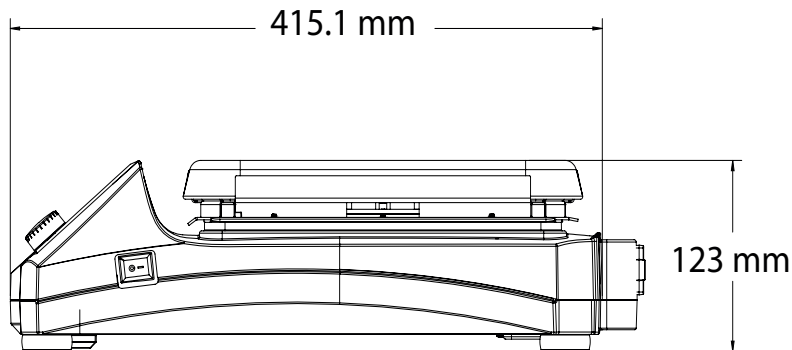
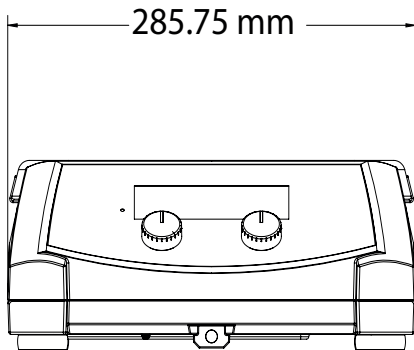

e-G51HSRDM

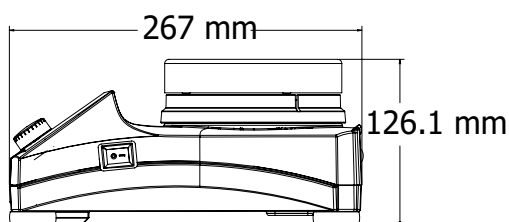
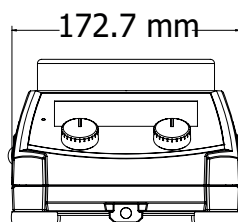

Other Features and Equipment

Green indicator lights when unit is heating and stirring, probe in use icon, Single Point Calibration icon, probe connection, IP21 Ingress Protection, polycarbonate front panel, control knobs, On/Off switch for heater disconnect, built-in support rod holder, audible alarm

Compliance

- **Product Safety:** IEC/EN 61010-1; IEC/EN 61010-2-010; IEC/EN 61010-2-051
- **Electromagnetic Compatibility:** IEC/EN 61326-1 Class A, Basic environments
- **Compliance Marks:** CE; RCM; TÜV SÜD; WEEE

OHAUS Europe GmbH

Heuwinkelstrasse 3,
8606 Nänikon,
Switzerland

e-mail: ssc@ohaus.com

Tel: 0041 22 567 53 19

e-mail: tsc@ohaus.com

Tel: 0041 22 567 53 20

www.ohaus.com

*The management system
governing the manufacture
of this product is ISO
9001:2015 certified.*

80776455_A 20200127 © Copyright OHAUS Corporation

